

# 9001 Series

## DIN41612 Half B Type Male

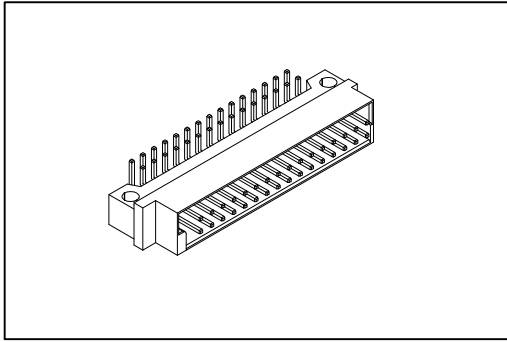

### Material:

Housing: Thermoplastic Polyester Glass Filled UL94V-0.  
 Contacts: Copper Alloy.

### Electrical Characteristics:

Current Rating: 2 A.  
 Dielectric Withstanding Voltage: AC 1000V.  
 Insulator Resistance: 1000MΩ min.  
 Contact Resistance: 20mΩ max.  
 Operating Temperature: -55°C ~ +125°C.

### Features:

- \* Mates with Female 2Row Half  
 9001-36 Half B Type.  
 9001-38 Half Q Type.

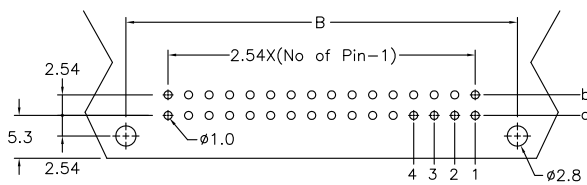
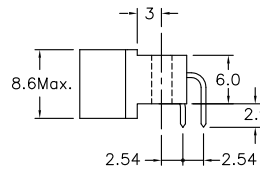
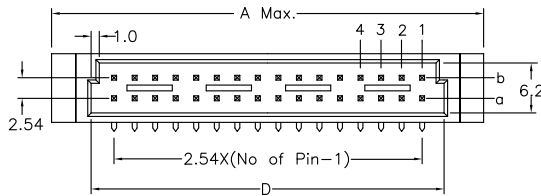
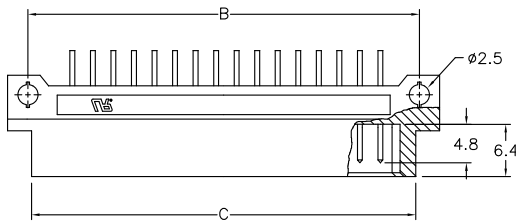

P.C. Board Layout

Dimension				
Position	A	B	C	D
32/16/8	54.00	48.26	47.40	44.60
20/10/5	38.04	33.02	31.80	29.40
Pitch	Position	Rows with Contacts	Contact Arrange	
2.54mm	32	a b		
	20	a b		
	16	a -		
5.08mm	10	a -		
	16	a b		
	10	a b		
	8	a -		
	5	a -		

## Ordering information

9001- 3 5 32 1 C 00 L1 A  
 Series 3: 2.54mm 5: Male 32: Position 1: Dip Length C: Selective Gold 00: G/F L1: With Lock A: Tray  
 4: 5.08mm Plated See Page CA03 Package

# 9001 Series

## DIN41612 Mating Introduce

2 Row insulator  
 B (Standard mounting)  
 Mounting axis  
 of the connector

3 Row insulator  
 C (Standard mounting)  
 Mounting axis  
 of the connector

Board lock available  
 L1=P.C.B. Thickness 1.6 ~2.0 mm  
 L2=P.C.B. Thickness 2.8 ~3.2 mm

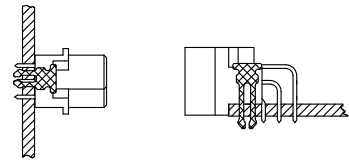
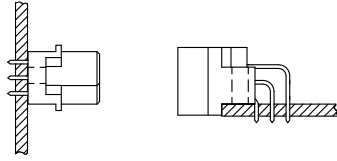
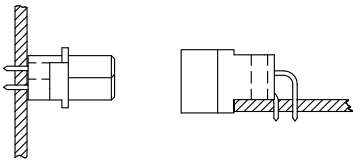

Q (Reverse mounting)  
 Mounting axis  
 of the connector

R (Reverse mounting)  
 Mounting axis  
 of the connector

Board lock available  
 L1=P.C.B. Thickness 1.6 ~2.0 mm  
 L2=P.C.B. Thickness 2.8 ~3.2 mm

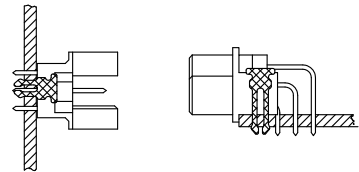
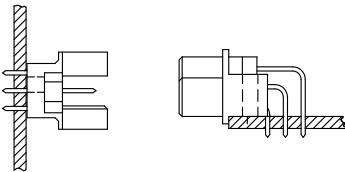
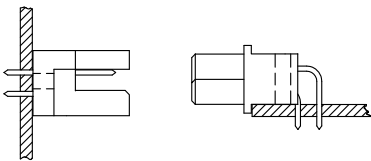

I.D.C. Type Ribbon Cable

Press Fit Type  
 2 Row insulator

3 Row insulator

2 Row insulator

3 Row insulator

