



Doc. Version	0.5
Total Page	16
Date	2008/05/23

# Product Specification

## 4.3" COLOR TFT-LCD MODULE

**MODEL NAME: C043GW01 V0**

<  > Preliminary Specification

<  > Final Specification

Note: The content of this specification is subject to change.

© 2006 AU Optronics  
All Rights Reserved,  
Do Not Copy.



## Record of Revision

Version	Revise Date	Page	Content
0.0	2008/04/22		First draft.
0.1	2008/04/24	6	Mechanical Drawing Update – add FPC length/ LED wire
		8	Remove Pin 37 DE, Replaced by GND Pin
		10	Suggested Application Circuit _ Drawing Update
		11	Timing Condition : modification Unit – Tdclk
		12	Vertical / Horizontal Timing Input update
		13	Clock and Data Timing Input : Remove DE
0.2	2008/05/02	6/7	Mechanical Drawing Update, add Rear View drawing
		11/12	Updated power on/off sequence
0.3	2008/05/02	15/16	Luminance Uniformity update
0.4	2008/05/08	6/7	Detailed Mechanical Drawing update
0.5	2008/05/23	6	Update Mechanical Drawing update (add LED connector Pin def.) / FPC modification



# Contents

<b>A. General Description</b>	<b>4</b>
<b>B. Features</b>	<b>4</b>
<b>C. Physical Specifications</b>	<b>5</b>
<b>D. Outline Dimension (Tentative)</b>	<b>6</b>
<b>E. Electrical Specification</b>	<b>7</b>
<b>1 Pin Assignment</b>	<b>7</b>
<b>2 Absolute Maximum Ratings</b>	<b>8</b>
<b>3 Electrical Characteristics</b>	<b>8</b>
<b>a.TFT-LCD Panel</b>	<b>8</b>
<b>b.Back Light Driving Condition</b>	<b>8</b>
<b>4 Suggested Application Circuit</b>	<b>9</b>
<b>5 AC Timing Condition</b>	<b>9</b>
<b>a. Power ON/OFF Sequence</b>	<b>9</b>
<b>b.TimingCondition</b>	<b>10</b>
<b>c. Timing Diagram</b>	<b>11</b>
<b>F. Optical Specifications</b>	<b>13</b>
<b>G. Reliability Test Items</b>	<b>15</b>
<b>H. Packing Form(TBD)</b>	<b>16</b>

## A. General Description

C043GW01 V0 is an a-Si type Thin Film Transistor Liquid crystal Display (TFT-LCD). This model is composed of a TFT-LCD, a driver, an FPC (flexible printed circuit), and a backlight unit.

## B. Features

- 4.3-inch display
- **400x234** resolution in RGB stripe dot arrangement
- DC/DC integrated
- High brightness
- Interfaces: parallel RGB 24-bit
- Wide viewing angle
- Green design

### C. Physical Specifications

NO.	Item	Unit	Specification	Remark
1	Display Resolution	dot	400 RGB (H)×234(V)	
2	Active Area	mm	94.8(H)×52.65(V)	
3	Screen Size	inch	4.3(Diagonal)	
4	Dot Pitch	mm	0.079(H)×0.225(V)	
5	Color Configuration	--	R. G. B. Stripe	Note 1
6	Color Depth	--	16M Colors	
7	Overall Dimension	mm	107.7(H) × 65.6(V) × 5.5(T)	Note 2
8	Weight	g	TBD	
9	Display Mode	--	Normally White	
10	Gray Level Inversion Direction		6 O'clock	

Note 1: Below figure shows dot stripe arrangement.

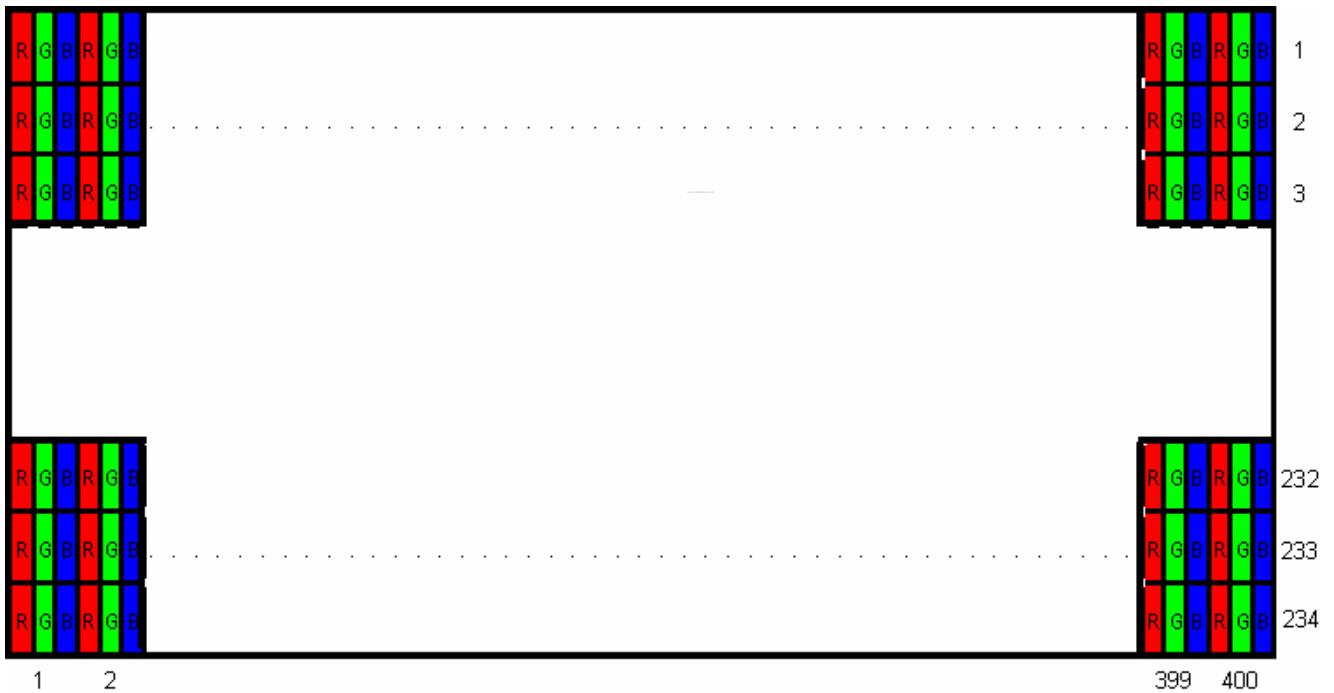

Note 2: Not including FPC. Refer to the drawing next page for further information.

### D. Outline Dimension (Tentative)

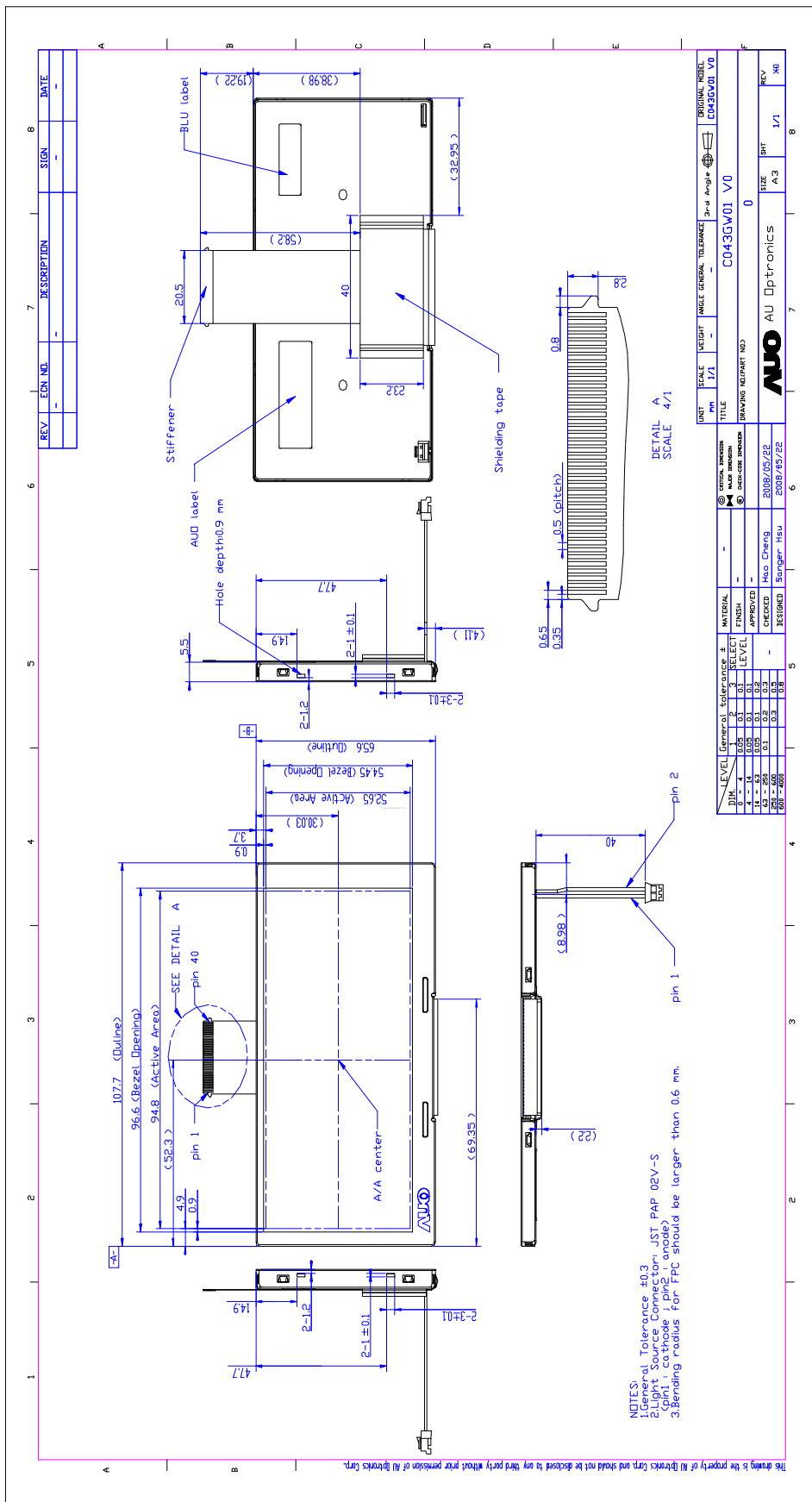

## E. Electrical Specifications

### 1. Pin Assignment Connector= FH28- 40S- 0.5SH (05)

No.	Pin Name	I/O	Description	Remarks
1	GND	G	GND	
2	GND	G	GND	
3	VDD	PI	Power supply	
4	VDD	PI	Power supply	
5	Reset	I	Re set H=normal ; L=reset	
6	DISP	I	Display on/off signal H=normal ; L=turn off	
7	GND	G	GND	
8	R0	I	Red Data Signal (LSB)	
9	R1	I	Red Data Signal	
10	R2	I	Red Data Signal	
11	R3	I	Red Data Signal	
12	R4	I	Red Data Signal	
13	R5	I	Red Data Signal	
14	R6	I	Red Data Signal	
15	R7	I	Red Data Signal (MSB)	
16	GND	G	GND	
17	G0	I	Green Data Signal (LSB)	
18	G1	I	Green Data Signal	
19	G2	I	Green Data Signal	
20	G3	I	Green Data Signal	
21	G4	I	Green Data Signal	
22	G5	I	Green Data Signal	
23	G6	I	Green Data Signal	
24	G7	I	Green Data Signal (MSB)	
25	GND	G	GND	
26	B0	I	Blue Data Signal (LSB)	
27	B1	I	Blue Data Signal	
28	B2	I	Blue Data Signal	
29	B3	I	Blue Data Signal	
30	B4	I	Blue Data Signal	
31	B5	I	Blue Data Signal	
32	B6	I	Blue Data Signal	
33	B7	I	Blue Data Signal (MSB)	
34	GND	G	Ground	
35	DCLK	I	Data Clock	
36	GND	G	Ground	

37	GND	G	Ground	
38	HSYNC	I	Horizontal synchronizing signal	
39	VSYNC	I	Vertical synchronizing signal	
40	GND	G	Ground	

I: Digital signal input, O: Digital signal output, G: GND, PI: Power input, C: Capacitor

## 2. Absolute Maximum Ratings

Items	Symbol	Values		Unit	Condition
		Min.	Max.		
Power Voltage	Vdd	-0.3	4.5	V	
Input Signal Voltage	Vi	-0.3	Vdd+ 0.3	V	
Operation Temperature	Topa	-30	+85	□	
Storage Temperature	Tstg	-40	+95	□	
LED	Vf	-	20	V	
	If	-	100	mA	

Note 1: Functional operation should be restricted under normal ambient temperature.

## 3. Electrical Characteristics

The following items are measured under stable condition and suggested application circuit.

### a. TFT- LCD Panel

Parameter	Symbol	Min	Typ	Max	Unit	Notes
Power Supply	Vdd	3.1	3.3	3.5	V	
Input high voltage	Vh	0.7Vdd	-	Vdd	V	
Input low voltage	VI	0	-	0.3Vdd		
Vertical cycle	f <sub>V</sub>	55	60	106	Hz	
Horizontal cycle	f <sub>H</sub>	15	16.2	28.8	kHz	
Dot Frequency	f <sub>DCLK</sub>	7.8	8.4	15	MHz	

### b. Backlight Driving Conditions

Parameter	Symbol	Min.	Typ.	Max.	Unit	Remark
LED Supply Current	I <sub>L</sub>	-	80	-	mA	single serial
LED Supply Voltage	V <sub>L</sub>	-	17.5	-	V	single serial
LED Life Time	L <sub>L</sub>	10000	---	---	Hr	Note 2

Note 1: LED backlight is 5 LEDs serial type.

Note 2: The LED lifetime could be decreased if operating I<sub>L</sub> is larger than 80mA



### 4. Suggested Application Circuit

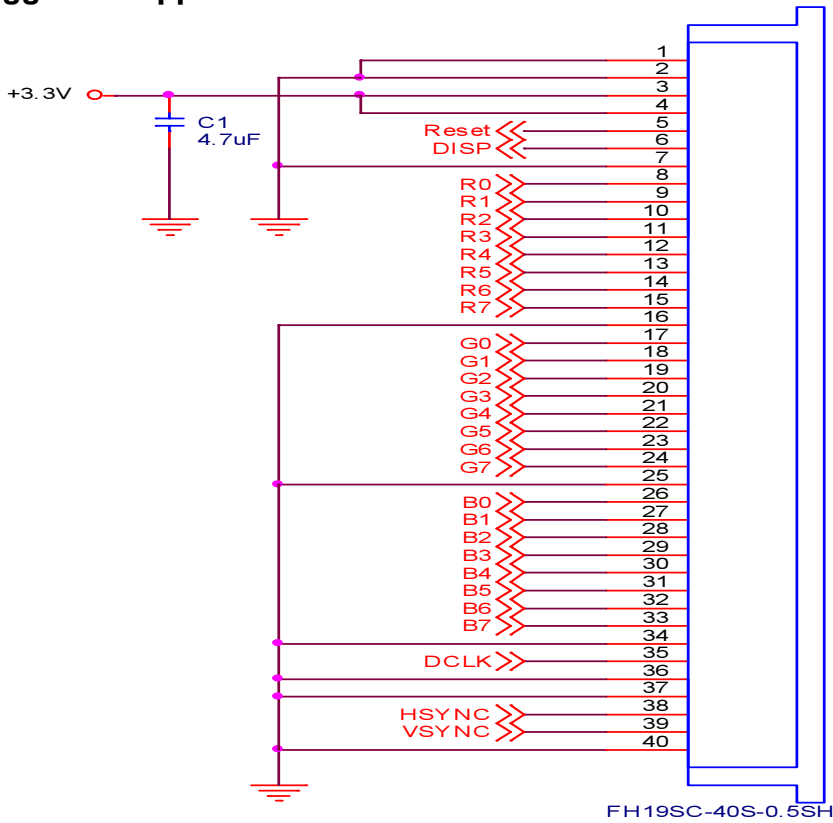

NOTE: The value of resistors is TBD.

### 4. AC Timing

#### a. Power on/off sequence

The LCD adopts high voltage driver IC, so it could be permanently damaged under a wrong power on/off sequence. The suggested LCD power sequence is below:

**Power on sequence: VDD→Reset→DCLK(Hsync,Vsync,Data)→DISP→ LED UNIT.**

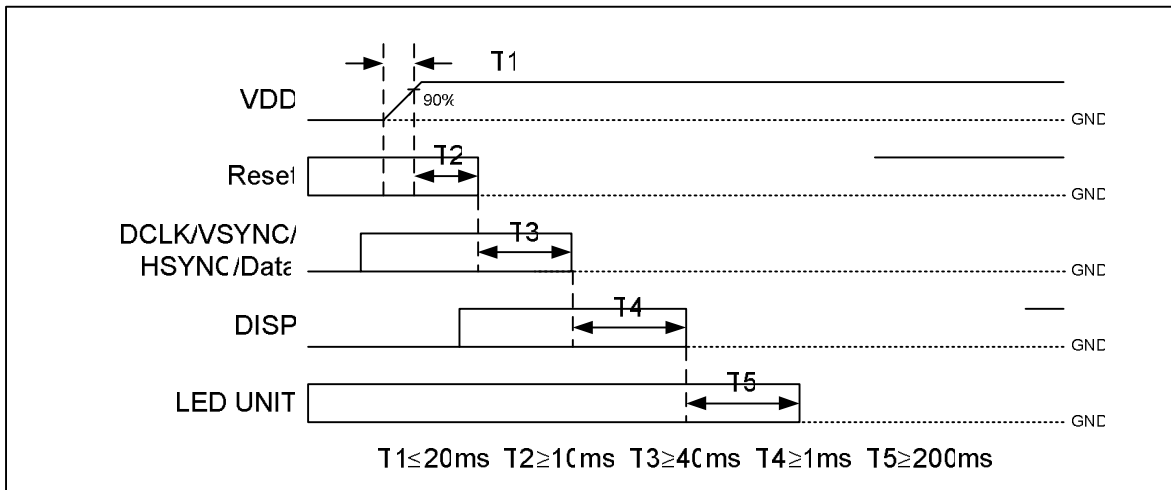

**Power-Off LED UNIT→DISP →DCLK(Hsync,Vsync,Data)→ VDD**

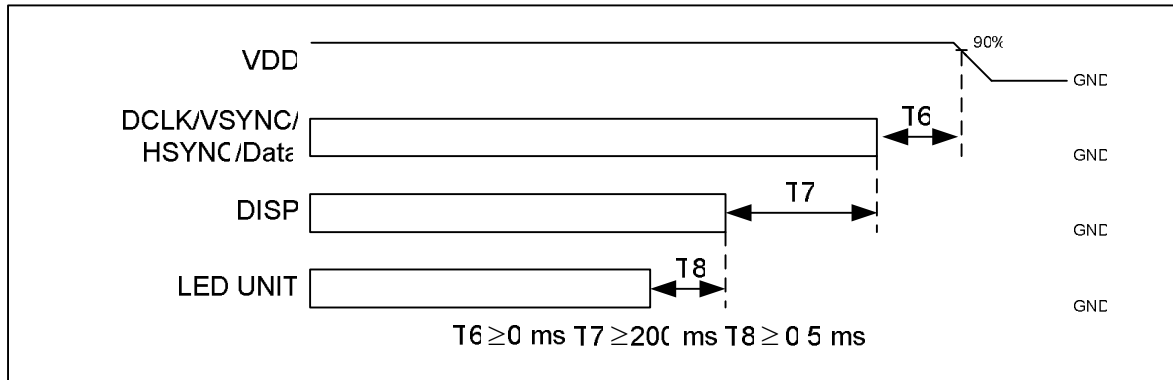

**b. Timing Condition**

Item	Symbol	Min	Typ	Max	Unit	Remark
Clock frequency	Fck	7.8	8.4	15	MHZ	
DCLK cycle time	Tdclk	67	119	—	ns	
DCLK pulth duty	Tcwh	40	50	60	%	
Hsync period	Th	—	520	—	Tdclk	
Hsync pulse width	Thw	—	1	—	Tdclk	
Hsync front porch	Thf	—	32	—	Tdclk	
Hsync back porch	Thb	—	88	—	Tdclk	
Hsync setup time	Thst	8			ns	
Hsync hold time	Thhd	8			ns	
Vsync period	Tv	—	270	—	Th	
Vsync pulse width	Tvw	—	1	—	Th	
Vsync front porch	Tvf	—	19	—	Th	
Vsync blanking	Tvbl	—	36	—	Th	
Vsync setup time	Tvst	8			ns	
Vsync hold time	Tvhd	8			ns	
Data setup time	Tds	8			ns	
Data hold time	Tdh	8			ns	

**c. Timing Diagram  
Vertical Timing of Input**

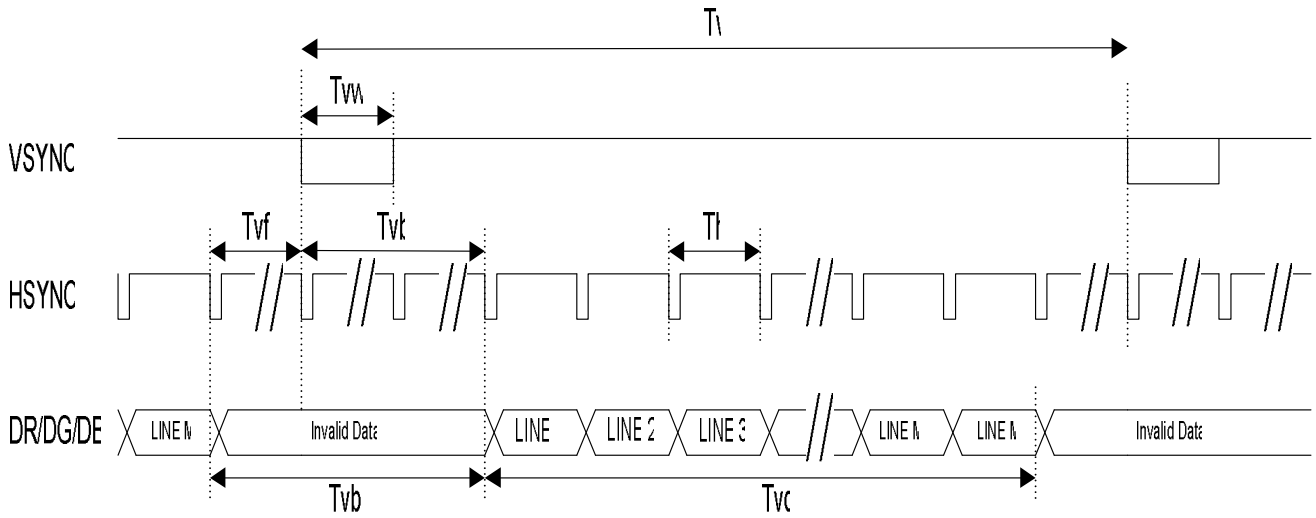

**Horizontal Timing of Input**

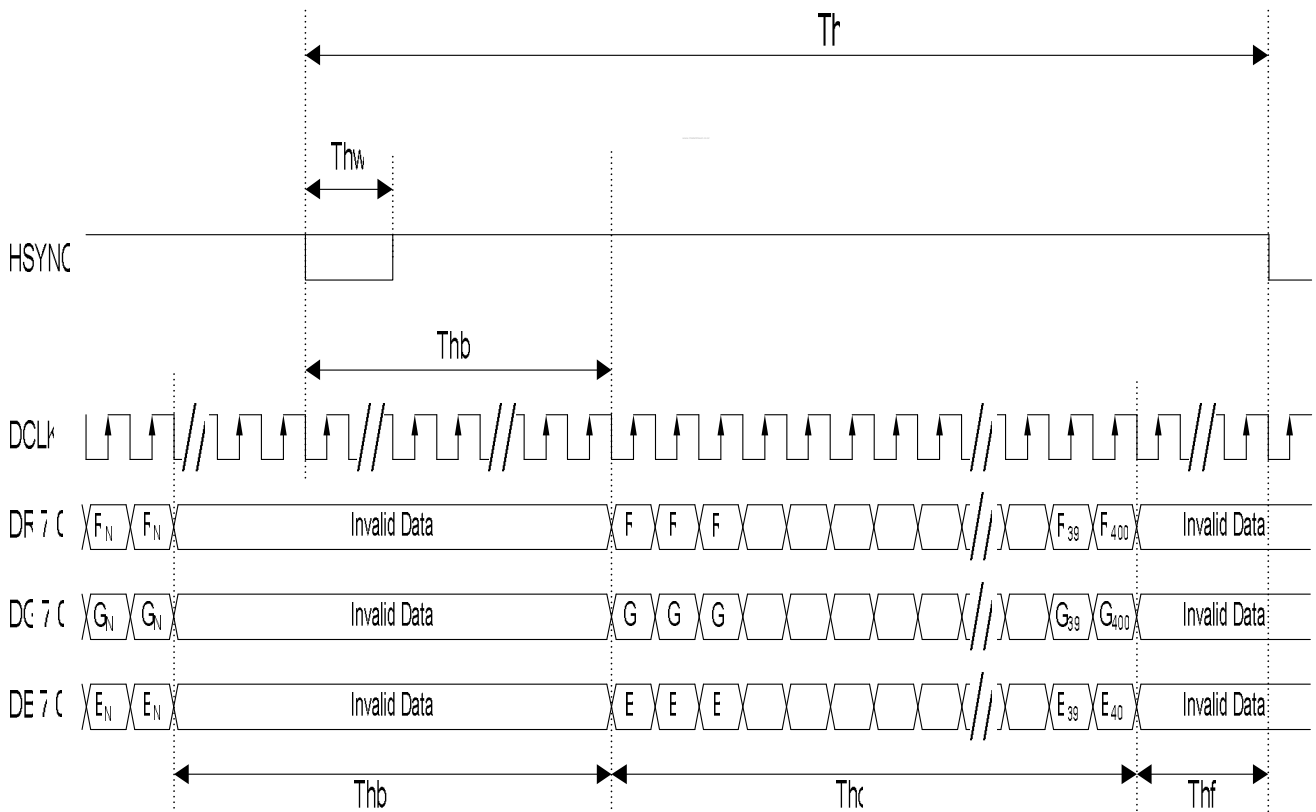

### Clock and Data Timing of Input

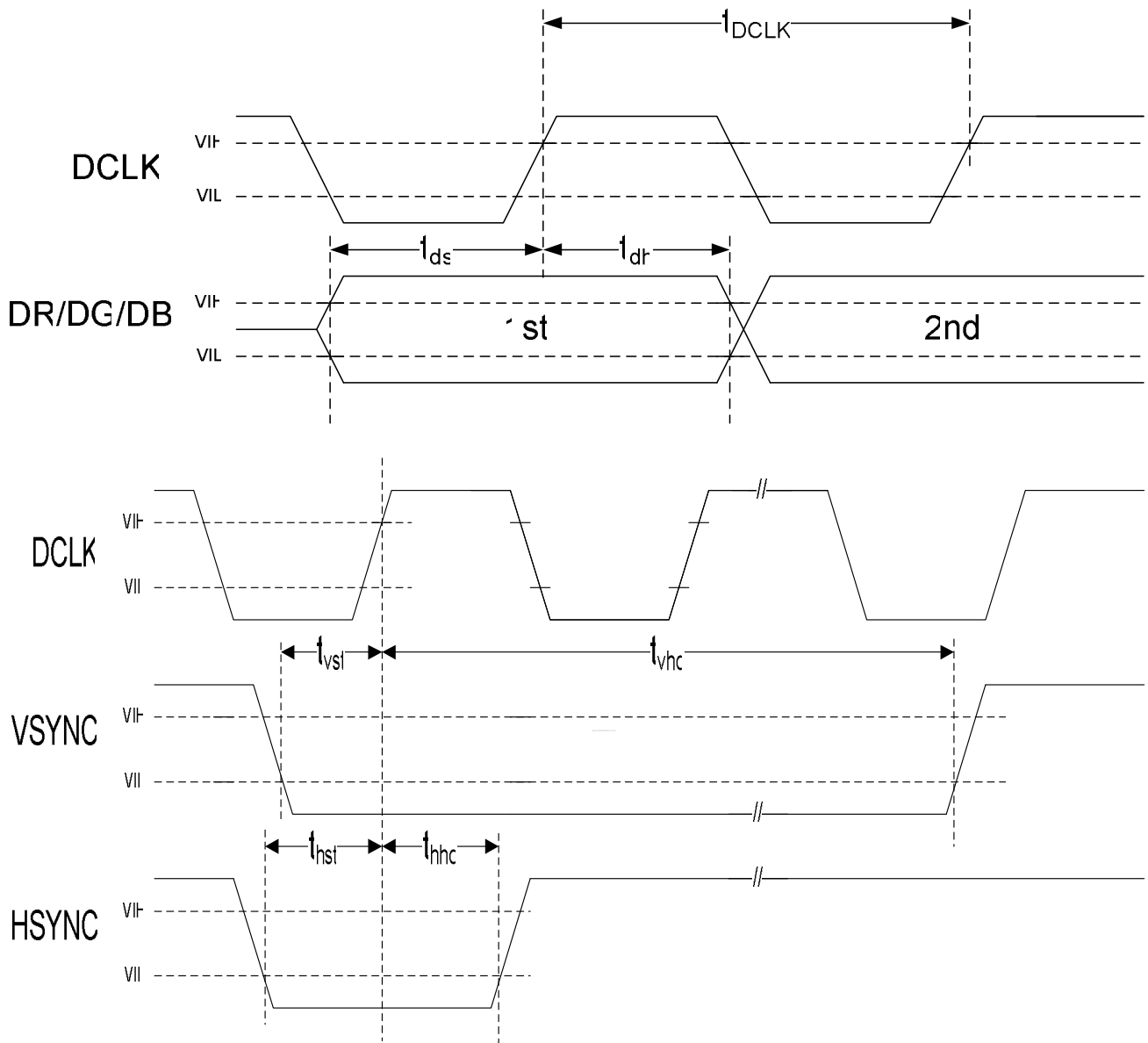

### F. Optical specifications (Note 1, 2)

Item	Symbol	Condition	Min.	Typ.	Max.	Unit	Remark
Response Time Rise Fall	Tr Tf	$\theta = 0^\circ$	- -	15 20		ms ms	Note 3
Contrast ratio	CR	At optimized viewing angle	400	-	-		Note 5, 6
Viewing Angle Top Bottom Left Right		$CR \geq 10$	30 50 50 50	40 60 60 60	- - - -	deg.	Note 7, 8
Brightness	$Y_L$	$\theta = 0^\circ$	TBD	600		cd/m <sup>2</sup>	Note 9
White Chromaticity	X	$\theta = 0^\circ$	0.26	0.31	0.36		
	y	$\theta = 0^\circ$	0.28	0.33	0.38		
Uniformity		-	70	-	-	%	Note 10

Note 1: Measurement should be performed in the dark room, optical ambient temperature =25°C, and backlight current  $I_L=80$  mA

Note 2: To be measured on the center area of panel with a field angle of 1° by Topcon luminance meter BM-7, after 10 minutes operation.

Note 3: Definition of response time:

The output signals of photo detector are measured when the input signals are changed from "black" to "white"(falling time) and from "white" to "black"(rising time), respectively.

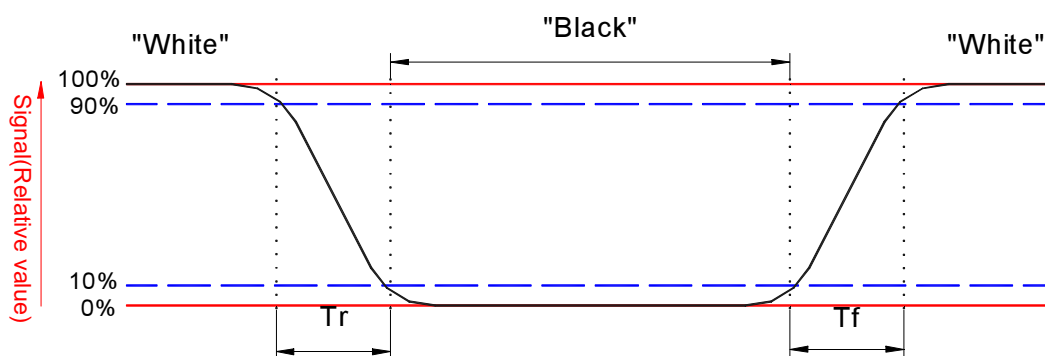

Note 4. From liquid crystal characteristics, response time will become slower and the color of panel will become darker when ambient temperature is below 25°C.

$$\text{Contrast ratio} = \frac{\text{Photo detector output when LCD is at "White" state}}{\text{Photo detector output when LCD is at "Black" state}}$$

Note 5. Contrast ratio is calculated with the following formula.

Note 6. White  $V_i = V_{i50} \mu 1.5V$

Black  $V_i = V_{i50} \pm 2.0V$

“±” means that the analog input signal swings in phase with COM signal.

“μ” means that the analog input signal swings out of phase with COM signal.

$V_{i50}$  :The analog input voltage when transmission is 50%

The 100% transmission is defined as the transmission of LCD panel when all the input terminals of module are electrically opened.

Note 7. Definition of viewing angle: refer to figure as below.

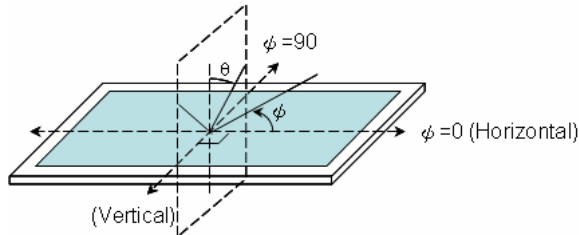

Note 8. The viewing angles are measured at the center area of the panel when all the input terminals of LCD panel are electrically opened.

Note 9. Brightness is measured at the center of the display perpendicular to the panel surface.

Note 10. Luminance Uniformity is defined as following within the 9 measurements (L1~L9),

Luminance Uniformity(%) = Minimum luminance(brightness)/Maximum luminance(brightness)

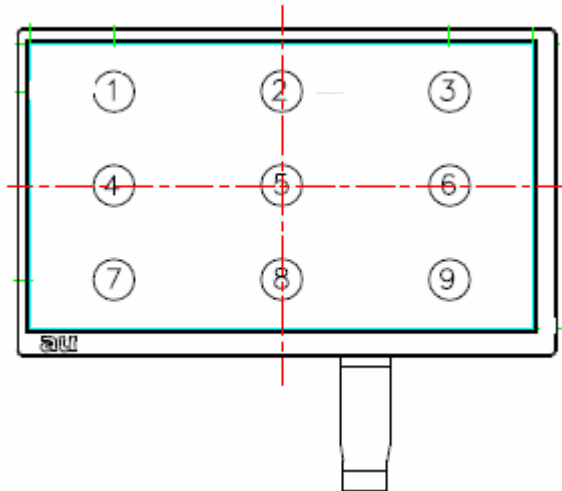

### G. Reliability Test Items

No.	Test items	Conditions		Remark
1	High temperature storage	Ta= 95□	240Hrs	
2	Low temperature storage	Ta= -40□	240Hrs	
3	High temperature operation	Tp= 85□	240Hrs	
4	Low temperature operation	Ta= -30□	240Hrs	
5	High temperature and high humidity	Tp= 60□, 90% RH	240Hrs	Operation
6	Heat shock	-30□~85□/100 cycles 1Hrs/cycle		Non-operation
7	Electrostatic discharge	±200V,200pF(0Ω), once for each terminal		Non-operation
8	Vibration	Frequency range	8~33.3Hz	JIS D1601,A10 Condition A
		Stoke	1.3mm	
		Sweep	2.9G, 33.3~400Hz	
		Cycle	15min.	
		2 hours for each direction of X, Z 4 hours for Y direction		
9	Mechanical shock	100G, 6ms, ±X,±Y,±Z 3 times for each direction		
10	Vibration (with carton)	Random vibration: 0.015G <sup>2</sup> /Hz from 5~200Hz -6dB/Octave from 200~500Hz		IEC 68-34
11	Drop (with carton)	Height: 60cm 1 corner, 3 edges, 6 surfaces		

Note 1: Ta: Ambient temperature.

Note 2: Tp: Panel Surface temperature.

Note 3: In the standard condition, there is not display function NG issue occurred. All the cosmetic specification is judged before the reliability stress.



## H. Packing Form - TBD