

RF-W \* ZM15T04-GE SERIES

**Description**

- ◆ Viewing angle:120 deg
- ◆ The materials of the LED dice is GaN
- ◆ 15mm×12mm×1.8mm
- ◆ RoHS compliant lead-free soldering compatible

**Package Outline**

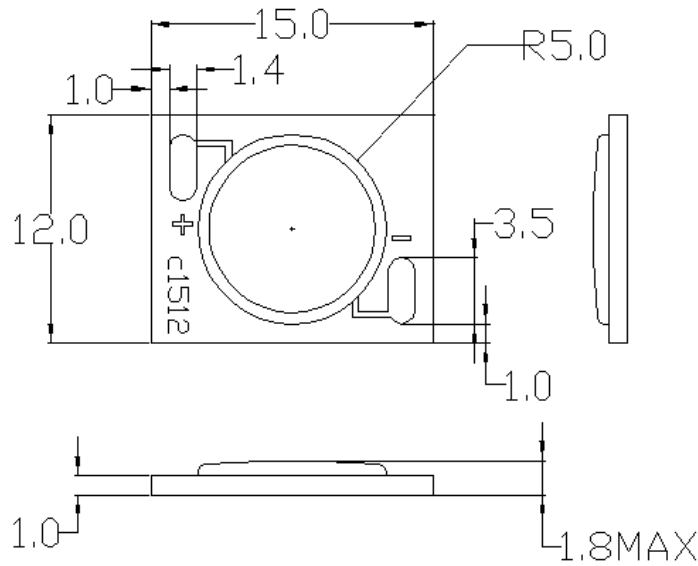

**Equivalent circuit**

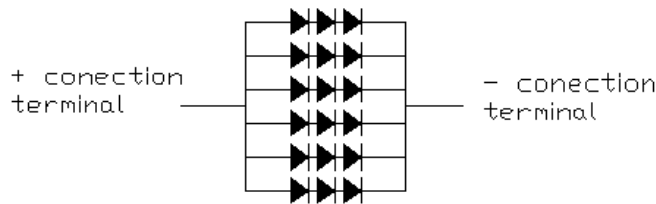



**ATTENTION**  
OBSERVE PRECAUTIONS  
FOR HANDLING  
ELECTROSTATIC  
SENSITIVE DEVICES

**NOTES:**

1. All dimensions are in millimeters (inches);
2. Tolerances are ±0.3mm (0.012inch) unless otherwise noted.

### Absolute maximum ratings at Ta=25°C

Parameter	Symbol	Value	Unit
Forward DC current	If	480	mA
Reverse DC voltage	Vr	5	V
Operating temperature range	Top	-40 ~+100	°C
Storage temperature range	Tstg	-40~+100	°C
Peak pulsing current	I <sub>fp</sub>	720	mA
Thermal Resistance	R <sub>thj-a</sub>	1.8	°C/W

### Electro-optical characteristics at Ta=25°C

Parameter	Test Condition	Symbol	Value			Unit
			Min.	Typ.	Max.	
Forward voltage	If=360mA	Vf	8	--	11	V
Luminous flux	If=360mA	Φ	300	--	400	lm
Reverse current	Vr=5V	I <sub>r</sub>	--	--	10	μA
Color Render Index	If=360mA	CRI	80	--	85	--
Correlated Color Temperature of 2700K	If=360mA	CCT	2600	--	2850	K
Correlated Color Temperature of 3000K	If=360mA	CCT	2850	--	3200	K
Correlated Color Temperature of 4000K	If=360mA	CCT	3700	--	4250	K
Correlated Color Temperature of 5000K	If=360mA	CCT	4750	--	5300	K

NOTE: (Tolerance: Φ ±10% , X/Y ±0.01 )

IFP Conditions : Pulse Width ≤ 10msec. and Duty ≤ 1/10.

Bin Information

RF-W2ZM15T04-GE Series Bin Information

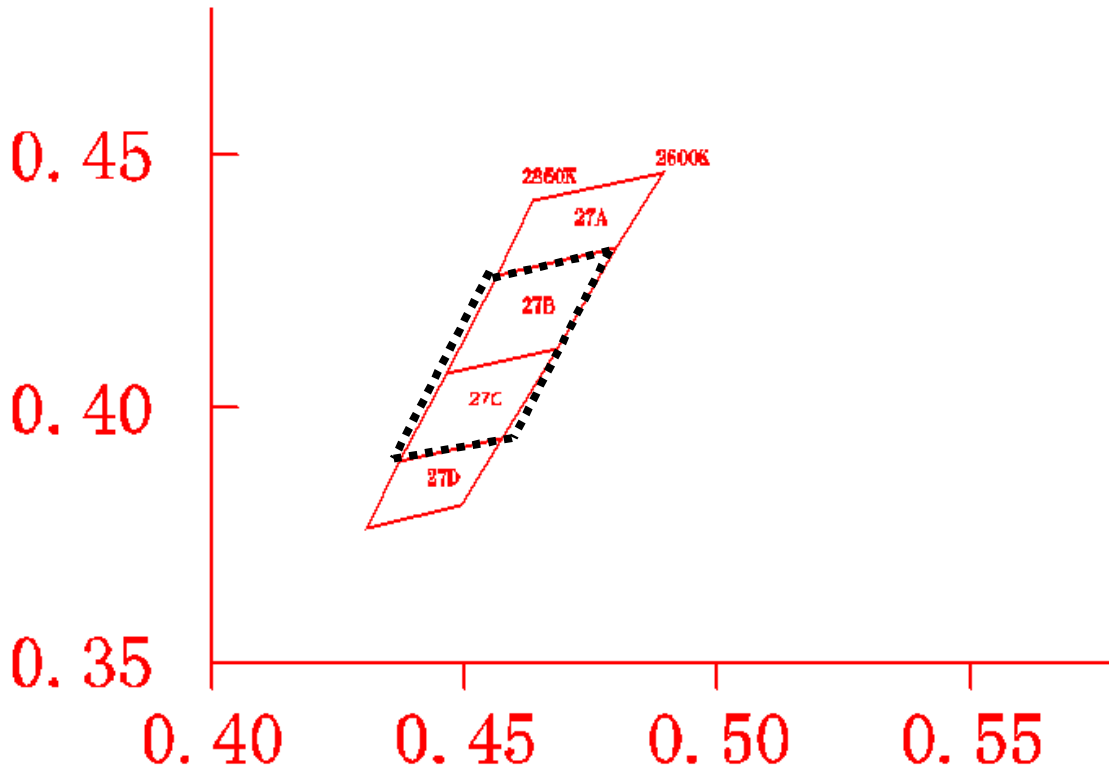

Note:  is high bin

Bin data:

BIN CODE	CIE-X1	CIE-Y1	CIE-X2	CIE-Y2	CIE-X3	CIE-Y3	CIE-X4	CIE-Y4
<b>27A</b>	0.4562	0.4260	0.4638	0.4407	0.4889	0.4466	0.4798	0.4316
<b>27B</b>	0.4562	0.4260	0.4464	0.4070	0.4682	0.4120	0.4798	0.4316
<b>27C</b>	0.4464	0.4070	0.4373	0.3893	0.4573	0.3939	0.4682	0.4120
<b>27D</b>	0.4373	0.3893	0.4573	0.3939	0.4495	0.3808	0.4307	0.3764

### Bin Information

RF-W3ZM15T04-GE Series Bin Information

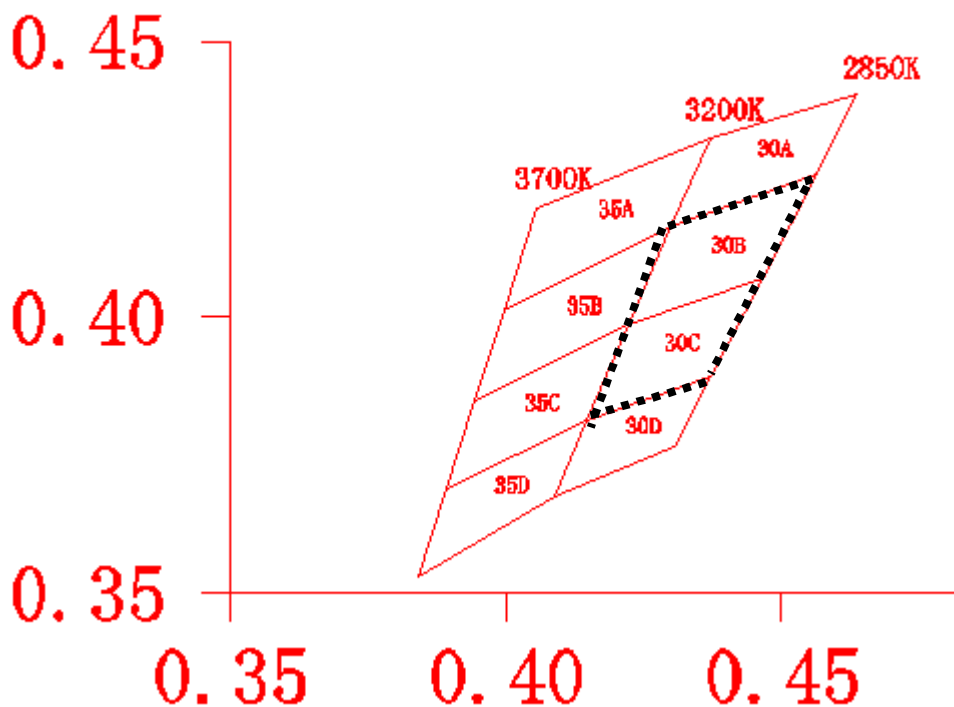

Note:  is high bin

### Bin data:

BIN CODE	CIE-X1	CIE-Y1	CIE-X2	CIE-Y2	CIE-X3	CIE-Y3	CIE-X4	CIE-Y4
<b>30A</b>	0.4369	0.4326	0.4299	0.4165	0.4562	0.4260	0.4638	0.4407
<b>30B</b>	0.4299	0.4165	0.4222	0.3987	0.4464	0.4070	0.4562	0.4260
<b>30C</b>	0.4222	0.3987	0.4147	0.3814	0.4373	0.3893	0.4464	0.4070
<b>30D</b>	0.4147	0.3814	0.4373	0.3893	0.4307	0.3764	0.4086	0.3674
<b>35A</b>	0.4057	0.4200	0.4369	0.4326	0.4299	0.4165	0.3997	0.4015
<b>35B</b>	0.4299	0.4165	0.3997	0.4015	0.3942	0.3849	0.4222	0.3987
<b>35C</b>	0.3942	0.3849	0.3892	0.3691	0.4147	0.3814	0.4222	0.3987
<b>35D</b>	0.3892	0.3691	0.4147	0.3814	0.4086	0.3674	0.3840	0.3529

### Bin Information

RF-W4ZM15T04-GE Series Bin Information

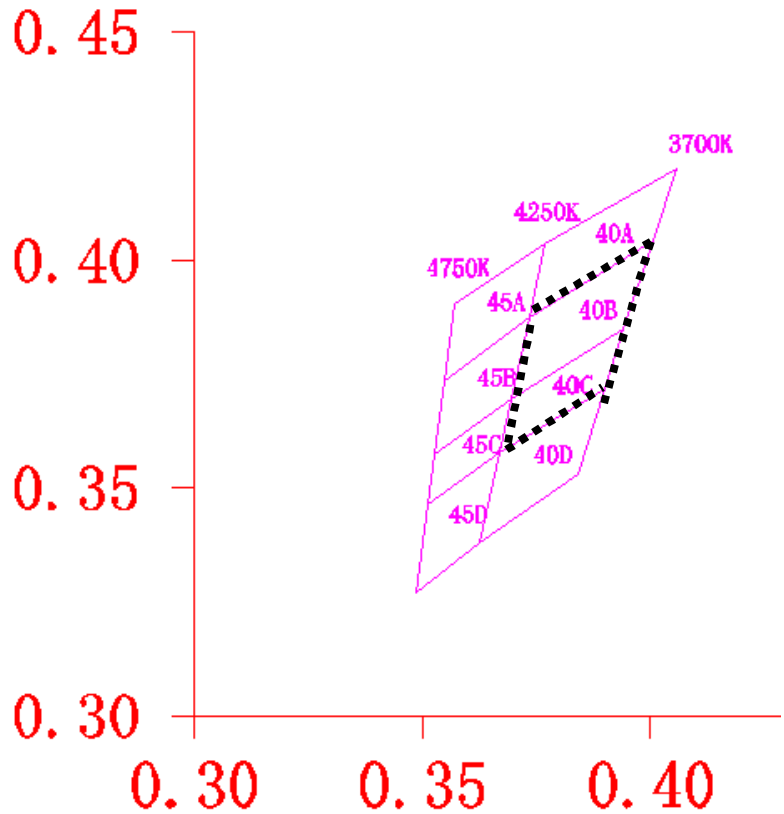



Note:  is high bin

#### Bin data:

BIN CODE	CIE-X1	CIE-Y1	CIE-X2	CIE-Y2	CIE-X3	CIE-Y3	CIE-X4	CIE-Y4
<b>40A</b>	0.3770	0.4035	0.4057	0.4200	0.4006	0.4044	0.3736	0.3874
<b>40B</b>	0.4006	0.4044	0.3736	0.3874	0.3697	0.3697	0.3942	0.3849
<b>40C</b>	0.3900	0.3717	0.3942	0.3849	0.3697	0.3697	0.3670	0.3578
<b>40D</b>	0.3670	0.3578	0.3900	0.3717	0.3840	0.3529	0.3626	0.3380
<b>45A</b>	0.3570	0.3901	0.3770	0.4035	0.3736	0.3874	0.3548	0.3736
<b>45B</b>	0.3736	0.3874	0.3548	0.3736	0.3527	0.3574	0.3697	0.3697
<b>45C</b>	0.3527	0.3574	0.3512	0.3465	0.3670	0.3578	0.3697	0.3697
<b>45D</b>	0.3512	0.3465	0.3670	0.3578	0.3626	0.3380	0.3487	0.3272

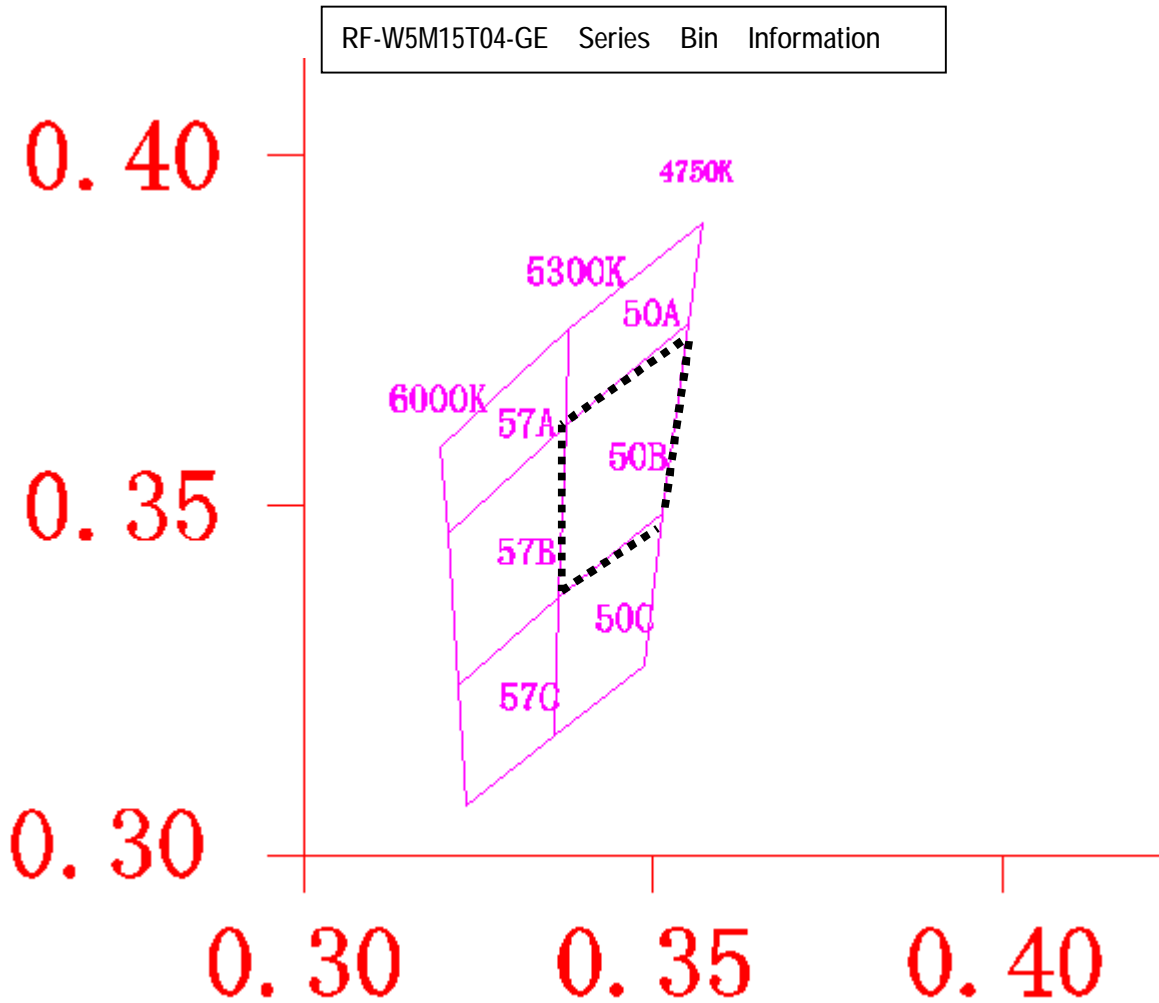
Bin Information



Note:  is high bin

Bin data:

BIN CODE	CIE-X1	CIE-Y1	CIE-X2	CIE-Y2	CIE-X3	CIE-Y3	CIE-X4	CIE-Y4
<b>50A</b>	0.3381	0.3751	0.3376	0.3616	0.3551	0.3760	0.3570	0.3901
<b>50B</b>	0.3376	0.3616	0.3366	0.3369	0.3515	0.3487	0.3551	0.3760
<b>50C</b>	0.3366	0.3369	0.3515	0.3487	0.3487	0.3272	0.3358	0.3171
<b>57A</b>	0.3198	0.3583	0.3206	0.3461	0.3376	0.3616	0.3381	0.3751
<b>57B</b>	0.3206	0.3461	0.3222	0.3243	0.3366	0.3369	0.3376	0.3616
<b>57C</b>	0.3222	0.3243	0.3235	0.3071	0.3358	0.3171	0.3366	0.3369

Lumilous flux(LM) BIN:

BIN CODE	MAX	MIN
LA	300	450

VF BIN:

BIN CODE	MAX	MIN
VA	8	11

Optical characteristics curves

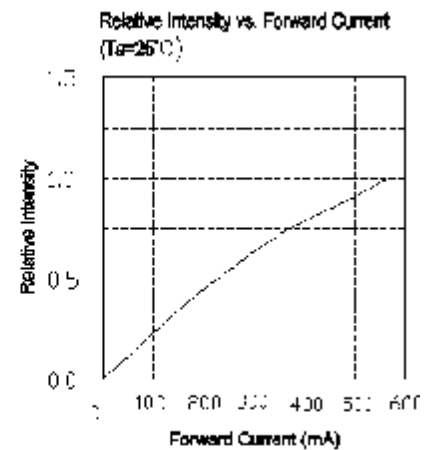
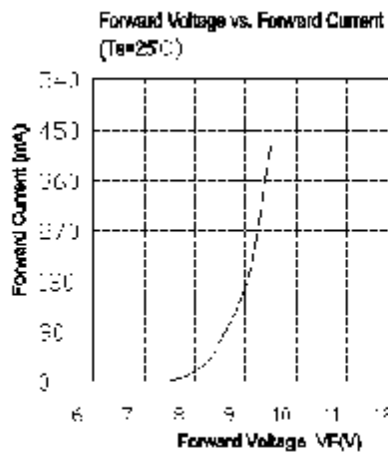
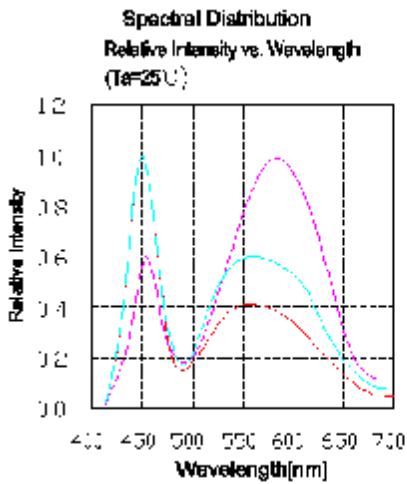

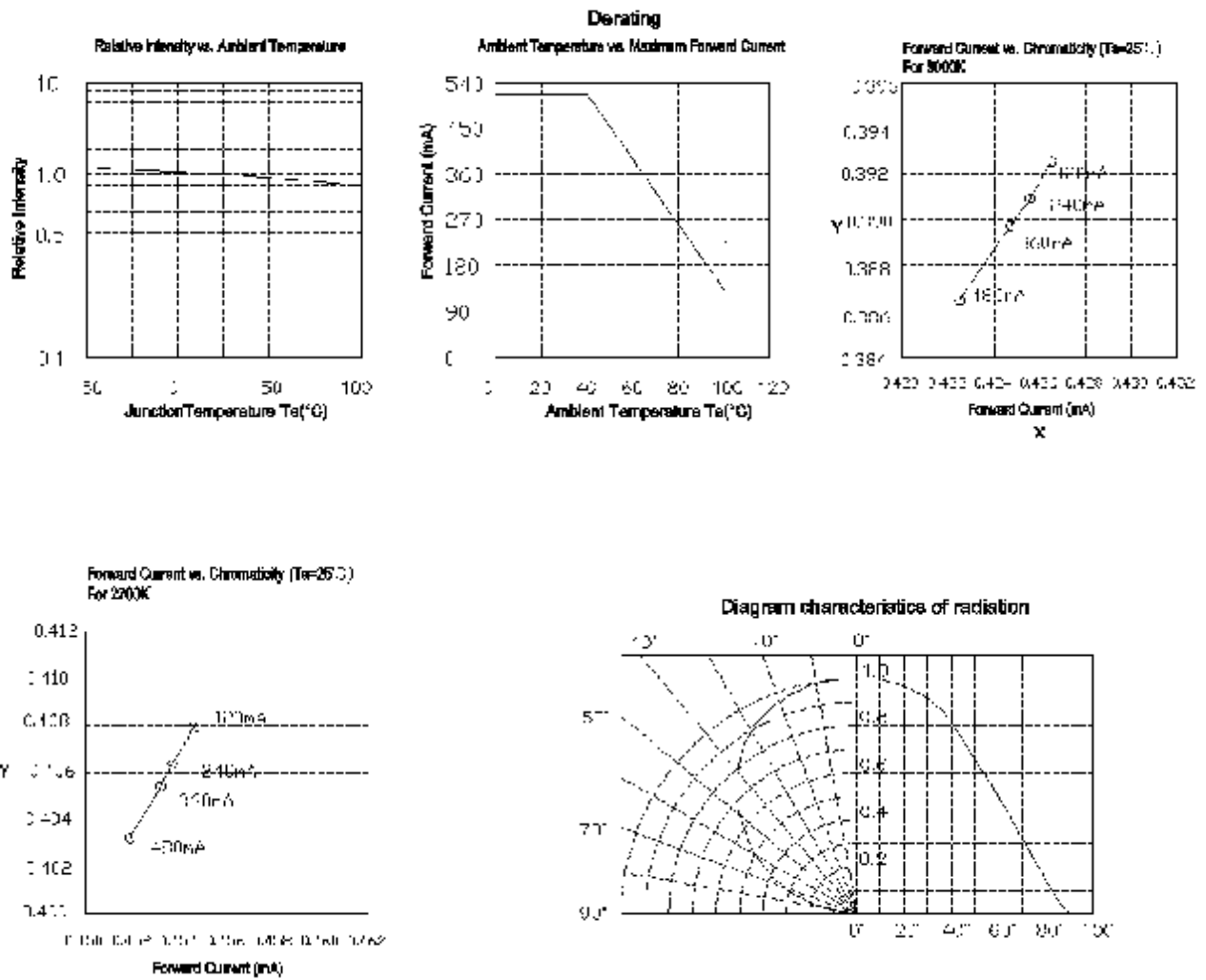

1. Reflow soldering should not be done more than two times
2. When soldering ,do not put stress on the LEDs during heating





Reliability

(1)TEST ITEMS AND RESULTS

Type	Test Item	Ref. Standard	Test Conditions	Note	Number of Damaged
Environmental Sequence	Temperature Cycle	JESD22A-104	-40°C 30min ↑↓ 100°C 30min	100 cycle	0/10
	High Temperature Storage	JESD22A-103	T <sub>a</sub> =100°C	1000 hrs	0/10
	Low Temperature Storage	JESD22A-119	T <sub>a</sub> =-40°C	1000 hrs	0/10
Operation Sequence	High Humidity Heat Life Test	JESD22A-101	60°C RH=90% I <sub>F</sub> =360mA	1000 hrs	0/10

(2)CRITERIA FOR JUDGING THE DAMAGE

Item	Symbol	Test Conditions	Criteria for Judgement	
			Min.	Max.
Forward Voltage	VF	IF=360mA	-	U.S.L*)×1.1
Reverse Current	IR	VR=5V	-	U.S.L*)×2.0
Luminous flux	Φ	IF=360mA	L.S.L**)×0.7	-

U.S.L.: Upper Standard Level

L.S.L.: Lower Standard Level

### Packaging Specifications

- Dimensions of Tube (Unit: mm)

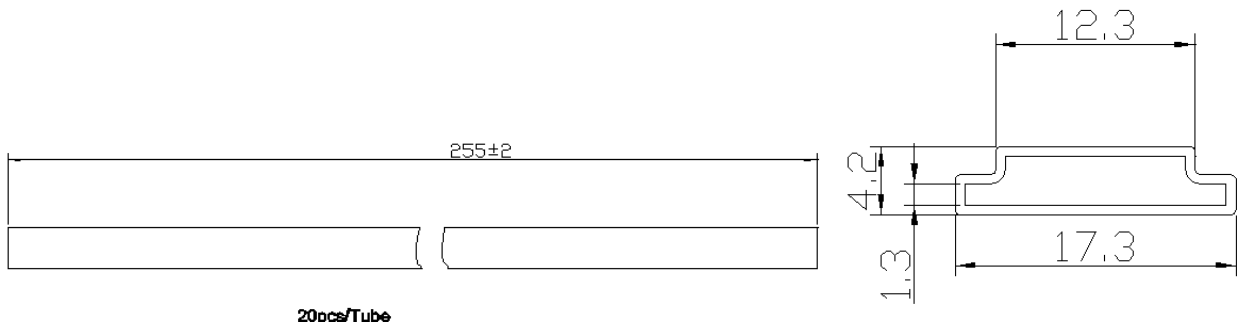

- Arrangement of Tube

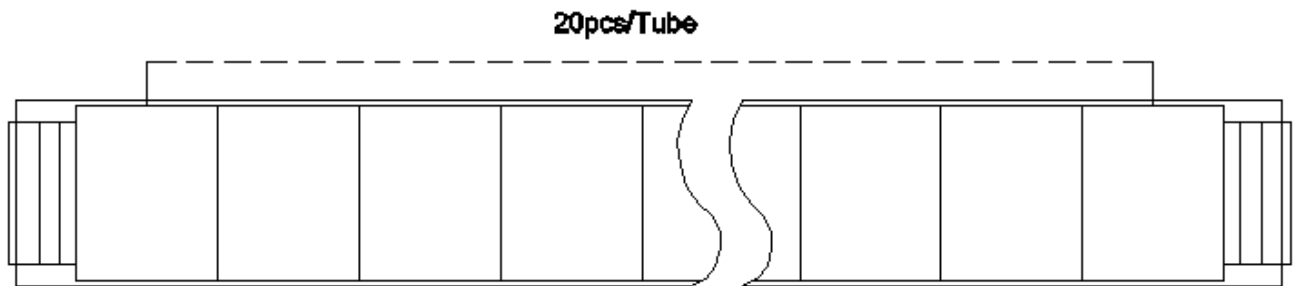



### NOTES

1.20pcs/Tube.

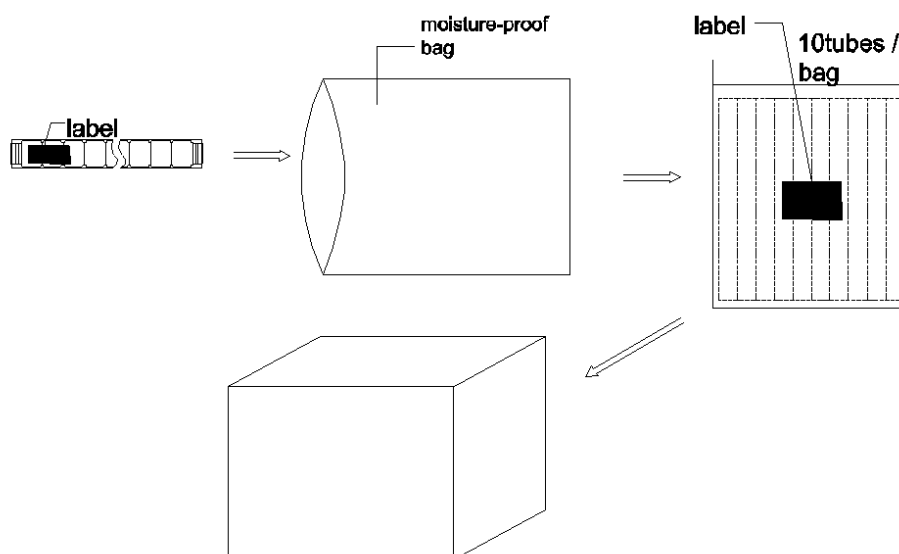
### Packaging specifications



## ■ Label

<b>PART NO.</b>	
	
<b>LOT NO.</b>	
	
<b>BIN CODE:</b>	<b>QTY: PCS</b>
	<b>DATE:</b>

## CAUTIONS

### Package specifications

Reeled products (numbers of products are 500pcs) packed in a seal off moisture-proof bag along with a desiccant one by one, Five moisture-proof bag of maximums (total maximum number of products are 2,500pcs) packed in an inside box (size: about 350mm x about 350 x about 165mm), and it is packed. (Part No., Lot No., quantity should appear on the label on the moisture-proof bag, part No. And quantity should appear on the label on the cardboard box.)

### Storage conditions

Before opening the package:

The LEDs should be kept at 30°C or less and 90%RH or less. The LEDs should be used within a year. When storing the LEDs, moisture proof packaging with absorbent material (silica gel) is recommended.

After opening the package:

The LEDs should be kept at 30°C or less and 70%RH or less. The LEDs should be soldered within 168 hours (7days) after opening the package. If unused LEDs remain, they should be stored in moisture proof packages, such as sealed containers with packages of moisture absorbent material (silica gel). It is also recommended to return the LEDs to the original moisture proof bag and to reseal the moisture proof bag again.