



SPECIFICATIONS FOR REFOND SURFACE MOUNT LED

Model: **RF-W3S118TS-A42**

Company Name: _____

Confirmed By
Customer: _____

DATE: _____

深圳市瑞豐光電子有限公司

SHENZHEN REFOND OPTOELECTRONICS CO.,LTD.

深圳市南山区松白路百旺信工业园二区第6栋

6th wing,2nd Second block of Baiwangxin Industry park

Songbai Road,Nanshan District ShenZhen,China,P.C:518108

TEL:0755-29675000

FAX:0755-29675111

<http://www.refond.com>

Feature

- ◆ Viewing angle:160 deg
- ◆ The materials of the LED dice is InGaN, AlGaInP
- ◆ 3.2mm×1.0mm×1.48mm SMT-LED
- ◆ RoHS compliant lead-free soldering compatible

Package Outline

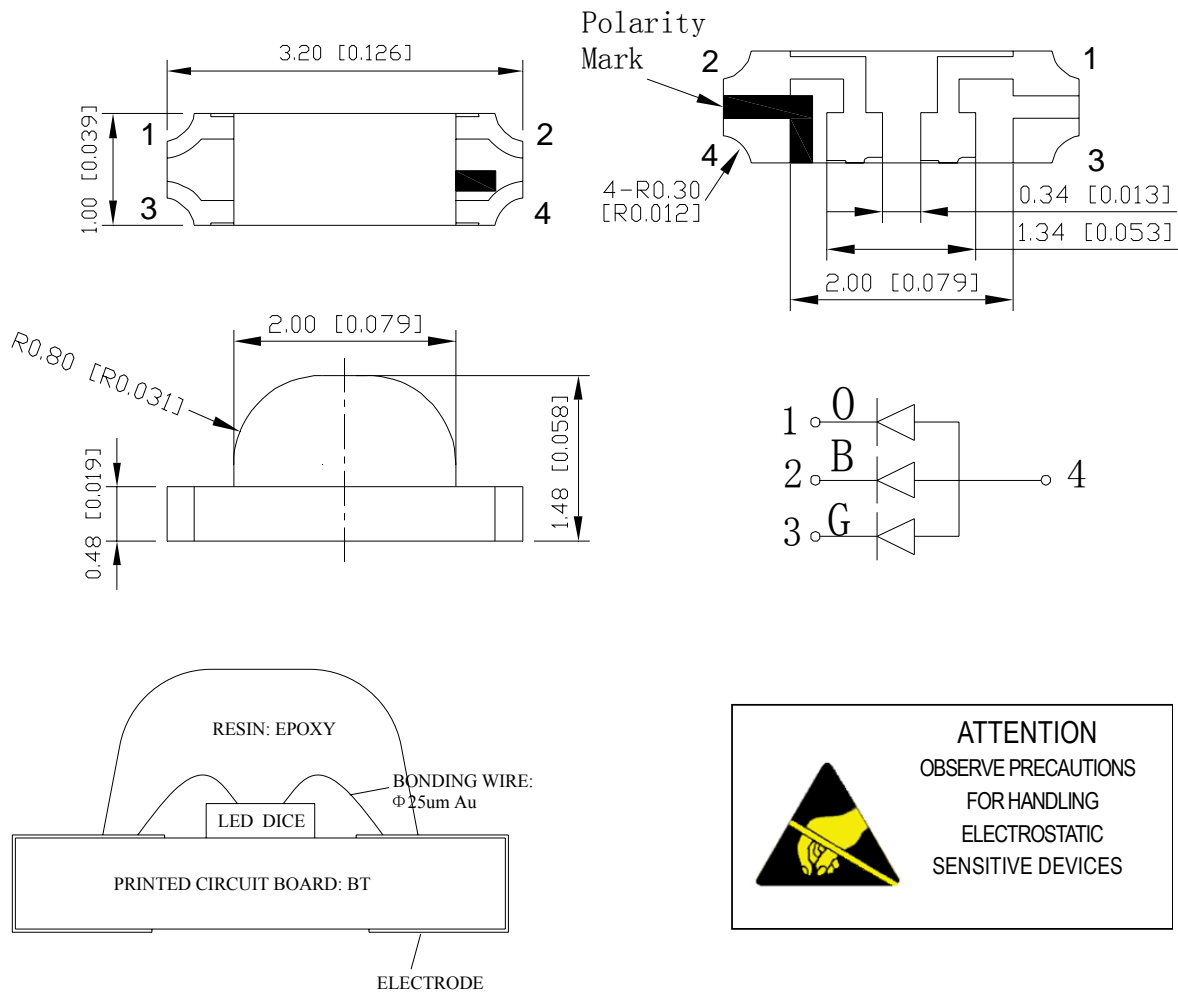

NOTES:

1. All dimensions are in millimeters (inches);
2. Tolerances are $\pm 0.1\text{mm}$ (0.004inch) unless otherwise noted.

APPROVED BY:		CHECKED BY:		PREPARED BY:	
DATE:		DATE:		DATE:	

Absolute maximum ratings at Ta=25°C

Parameter	Symbol	Value			Unit
		O	G	B	
Power dissipation	Pd	50	70	70	mW
Forward current	If	20			mA
Reverse voltage	Vr	5			V
Operating temperature range	Top	-40 ~ +100			°C
Storage temperature range	Tstg	-40 ~ +100			°C
Pulse Forward Current	Ifp	100			mA
Electrostatic Discharge	ESD	2000(HBM)			V

Electro-optical characteristics at Ta=25°C

Parameter	Test Condition	Symbol	Value			Unit	
			Min.	Typ.	Max.		
Wavelength at peak emission	If=20mA	λ_{peak}	O	--	--	--	nm
			G	--	--	--	
			B	--	--	--	
Spectral Half andwidth	If=20mA	$\Delta\lambda$	O	--	15	--	nm
			G	--	30	--	
			B	--	30	--	
Forward voltage	If=20mA	Vf	O	1.8	--	2.4	V
			G	2.9	--	3.5	
			B	2.9	--	3.5	
Dominant wavelength	If=20mA	λ_d	O	620	--	630	nm
			G	520	--	530	
			B	465	--	475	
Luminous intensity	If=20mA	Iv	O	90	--	150	mcd
			G	150	--	300	
			B	60	--	150	
Viewing angle at 50% Iv	If=20mA	2 θ 1/2	--	160	--	Deg	
Reverse current	Vr=5V	Ir	--	--	10	μ A	

NOTE: (Tolerance: Iv \pm 10%, λ_d \pm 2nm, Vf \pm 0.05V)

IFP Conditions: Pulse Width \leq 10msec. and Duty \leq 1/10.

Typical optical characteristics curves

Spectral Distribution

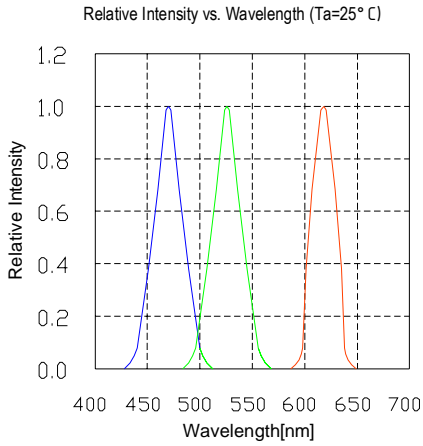

Forward Voltage vs. Forward Current (Ta=25°C)

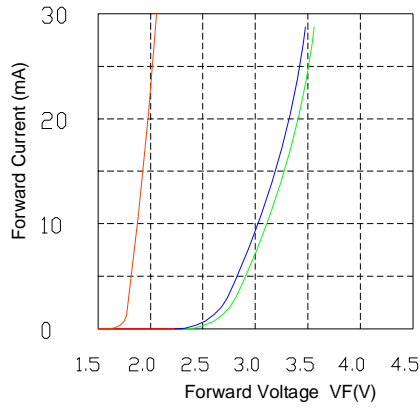

Relative Intensity vs. Forward Current (Ta=25°C)

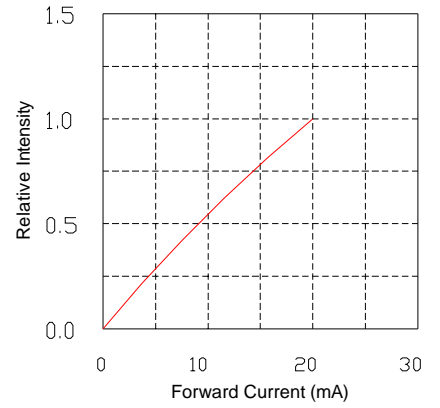

Derating

Relative Intensity vs. Ambient Temperature

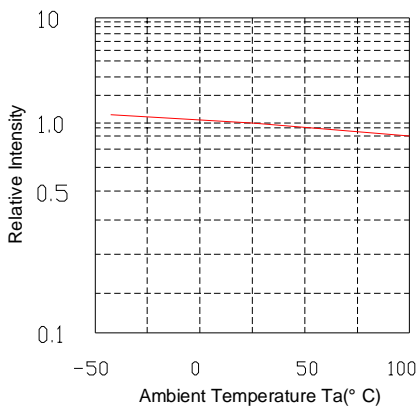

Ambient Temperature vs. Maximum Forward Current

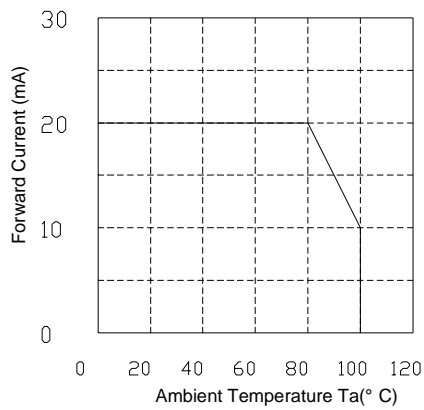

Forward Current vs. Dominate wavelength (Ta=25°C)

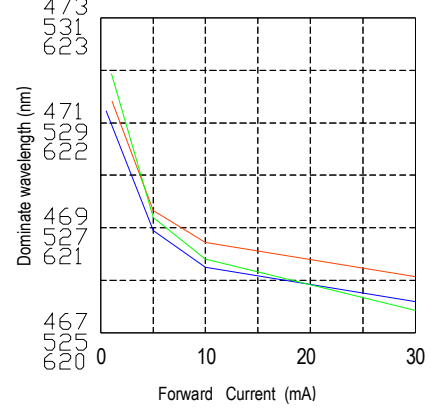
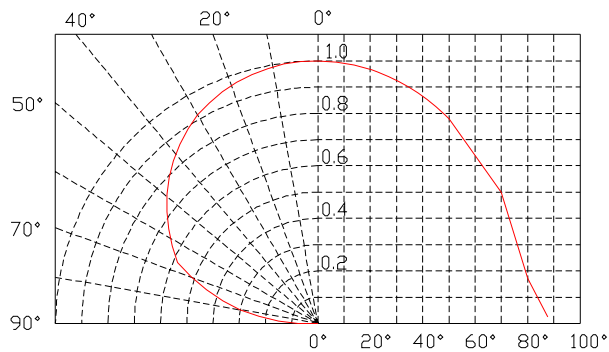

Diagram characteristics of radiation



Reflow profile

■ Soldering condition

- Recommended soldering conditions

Reflow Soldering		Hand Soldering	
Pre-heat	160~180°C	Temperature	300°C Max.
Pre-heat time	120 seconds Max.	Soldering time	3 second Max. (one time only)
Peak temperature	260°C Max.		
Soldering time	10 seconds Max.		
Condition	Refer to Temperature-profile		

- After reflow soldering rapid cooling should be avoided

■ Temperature-profile (Surface of circuit board)

Use the following conditions shown in the figure.

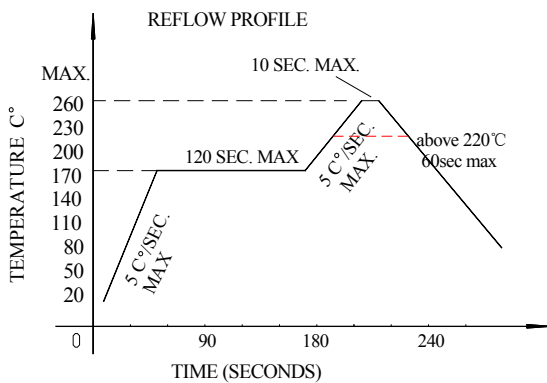

RECOMMEND PAD DESIGN (Units: mm)

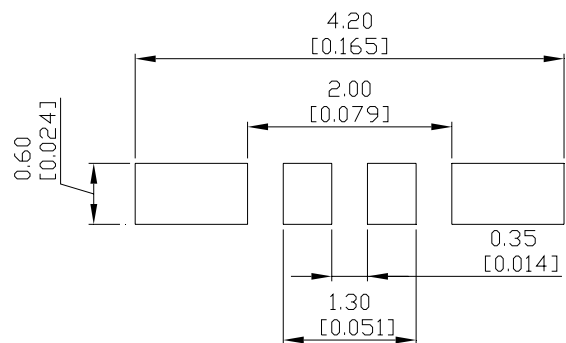

1. Reflow soldering should not be done more than two times
2. When soldering, do not put stress on the LEDs during heating

■ Soldering iron

1. When hand soldering, keep the temperature of the iron under 300°C, and at that temperature keep the time under 3 sec.
2. The hand soldering should be done only a time
3. The basic spec is ≤ 5 sec. when the temperature of 260°C, do not contact the resin when hand soldering

■ Rework

1. Customer must finish rework within 5 sec under 260°C
2. The head of iron can not touch the resin
3. Twin-head type is preferred.

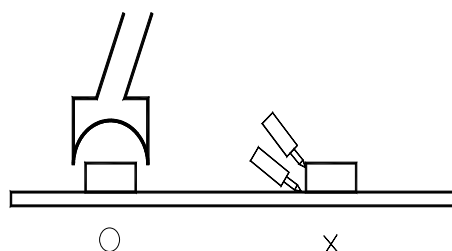

Reliability

(1) TEST ITEMS AND RESULTS

Type	Test Item	Ref. Standard	Test Conditions	Note	Number of Damaged
Environmental Sequence	Resistance to Soldering Heat(Reflow Soldering)	JESD22-B106	Tsld=260°C,10sec	2 times	0/22
	Temperature Cycle	JESD22-A104	-40°C 30min ↑↓5min 100°C 30min	1000 cycle	0/100
	Thermal Shock	JESD22-A106	-40°C 15min ↑↓ 100°C 15min	1000 cycle	0/100
	High Temperature Storage	JESD22-A103	T _a =100°C	1000 hrs	0/100
	Low Temperature Storage	JESD22-A119	T _a =-40°C	1000 hrs	0/100
	Power temperature cycling	JESD22-A105	On 5min -40°C>15min ↑↓ ↑↓<15min Off5min 100°C>15min	100 cycle	0/100
Operation Sequence	Life Test	JESD22-A108	T _a =25°C I _F =20mA	1000 hrs	0/100
	High Humidity Heat Life Test	JESD22-A101	60°C RH=90% I _F =20mA	1000 hrs	0/100

(2) CRITERIA FOR JUDGING THE DAMAGE

Item	Symbol	Test Conditions	Criteria for Judgement	
			Min.	Max.
Forward Voltage	VF	IF=10mA	-	U.S.L*)×1.1
Reverse Current	IR	VR=5V	-	U.S.L*)×2.0
Luminous Intensity	IV	IF=10mA	L.S.L**)×0.7	-

U.S.L.: Upper Standard Level

L.S.L.: Lower Standard Level

Packaging Specifications

● Feeding Direction

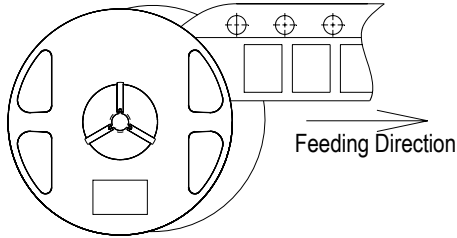

● Dimensions of Reel (Unit: mm)

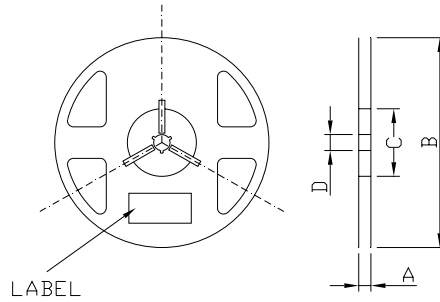

A	8.0±0.1mm
B	178±1mm
C	60±1mm
D	13.0±0.5mm

● Dimensions of Tape (Unit: mm)

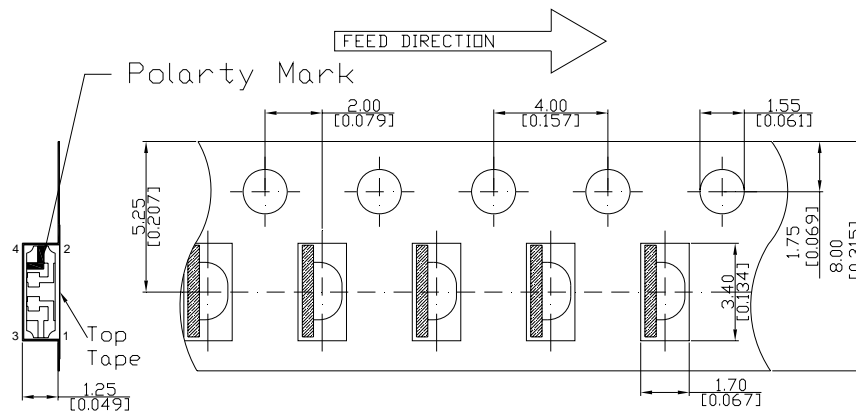

● Arrangement of Tape

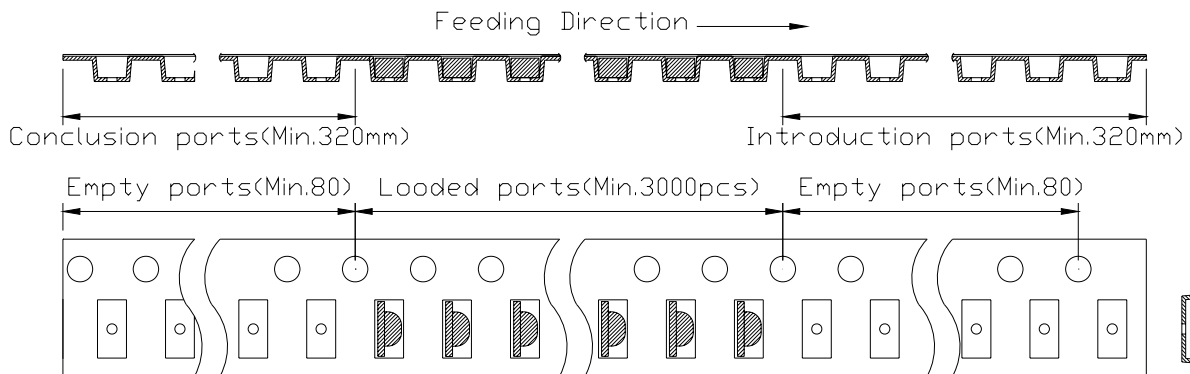



NOTES

1. Empty component pockets are sealed with top cover tape;
2. The maximum number of missing lamps is two;
3. 3,000 pcs/ Reel.

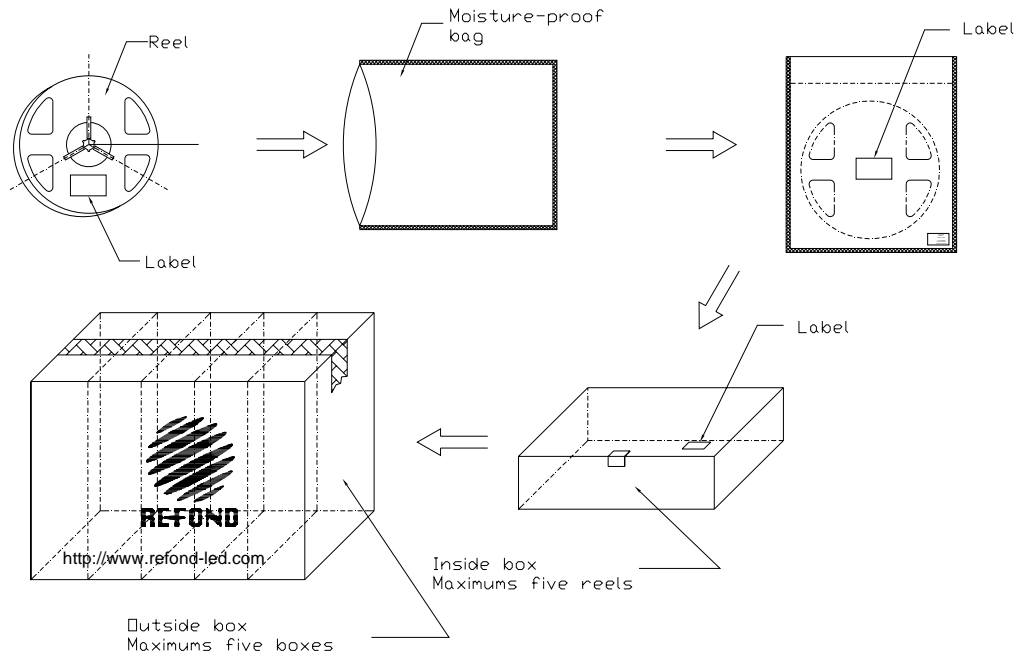
Packaging specifications



Label

PART NO.	
	
LOT NO.	
	
BIN CODE:	QTY: PCS
	DATE:

CAUTIONS

Package specifications

Reeled products (numbers of products are 3,000pcs) packed in a seal off moisture-proof bag along with a desiccant one by one, Five moisture-proof bag of maximums (total maximum number of products are 15,000pcs) packed in an inside box (size: about 250mm x about 250 x about 68mm) and Five inside boxes of maximums are put the outside box (size: about 360mm x about 265mm x about 255mm) Together with buffer material, and it is packed. (Part No., Lot No., quantity should appear on the label on the moisture-proof bag, part No. And quantity should appear on the label on the cardboard box.) The number of the loading steps of outside box (cardboard box) has three steps.

Storage conditions

Before opening the package:

The LEDs should be kept at 30°C or less and 90%RH or less. The LEDs should be used within a year. When storing the LEDs, moisture proof packaging with absorbent material (silica gel) is recommended.

After opening the package:

The LEDs should be kept at 30°C or less and 70%RH or less. The LEDs should be soldered within 168 hours (7days) after opening the package. If unused LEDs remain, they should be stored in moisture proof packages, such as sealed containers with packages of moisture absorbent material (silica gel). It is also recommended to return the LEDs to the original moisture proof bag and to reseal the moisture proof bag again.