

Feature

- ◆ Viewing angle:140 deg
- ◆ The materials of the LED dice is AlInGaP
- ◆ 3.20mm×1.60mm×0.70mm
- ◆ RoHS compliant lead-free soldering compatible

RF-AUS150TS-ED

Package Outline

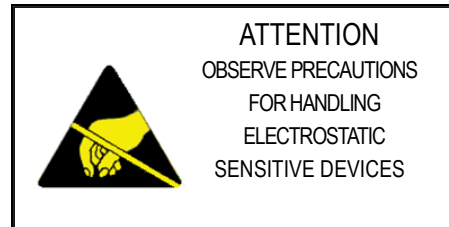
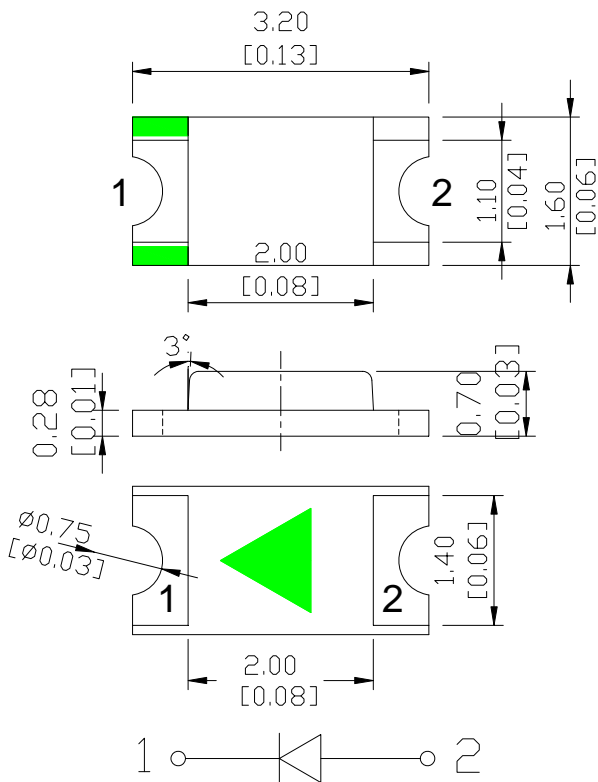

NOTES:

1. All dimensions are in millimeters (inches);
2. Tolerances are $\pm 0.1\text{mm}$ (0.004inch) unless otherwise noted.

Absolute maximum ratings at Ta=25°C

| Parameter | Symbol | Value | Unit |
|-----------------------------|--------|-----------|------|
| Forward current | If | 20 | mA |
| Reverse voltage | Vr | 5 | V |
| Operating temperature range | Top | -20 ~+85 | °C |
| Storage temperature range | Tstg | -35 ~+85 | °C |
| Peak pulsing current | Ifp | 100 | mA |
| Electrostatic Discharge | ESD | 2000(HBM) | V |

Electro-optical characteristics at Ta=25°C

| Parameter | Test Condition | Symbol | Value | | | Unit |
|-------------------------|----------------|-----------------|-------|------|------|---------|
| | | | Min. | Typ. | Max. | |
| Spectral half bandwidth | If=20mA | $\Delta\lambda$ | -- | 15 | -- | nm |
| Forward voltage | If=20mA | Vf | 1.8 | -- | 2.0 | V |
| | | | 2.0 | -- | 2.2 | V |
| | | | 2.2 | -- | 2.4 | V |
| Dominant wavelength | If=20mA | λ_d | 600 | -- | 605 | nm |
| | | | 605 | -- | 610 | nm |
| | | | 610 | -- | 615 | nm |
| Luminous intensity | If=20mA | Iv | 70 | -- | 90 | mcd |
| | | | 90 | -- | 120 | mcd |
| | | | 120 | -- | 150 | mcd |
| | | | 150 | -- | 200 | mcd |
| | | | 200 | -- | 260 | mcd |
| Viewing angle at 50% Iv | If=20mA | 2 θ 1/2 | -- | 140 | -- | Deg |
| Reverse current | Vr=5V | Ir | -- | -- | 10 | μ A |

NOTE: (Tolerance: Iv \pm 10%, λ_d \pm 2nm, Vf \pm 0.05V)

IFP Conditions: Pulse Width \leq 10msec. and Duty \leq 1/10.

Typical optical characteristics curves

Spectral Distribution

Relative Intensity vs. Wavelength (Ta=25°C)

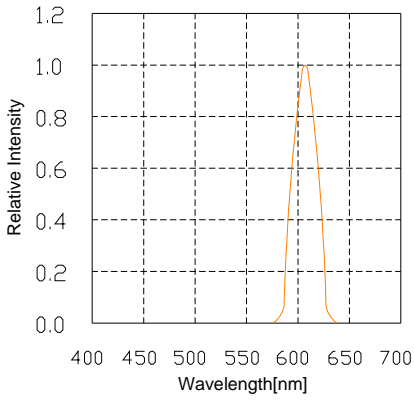

Forward Current vs. Forward Voltage (Ta=25°C)

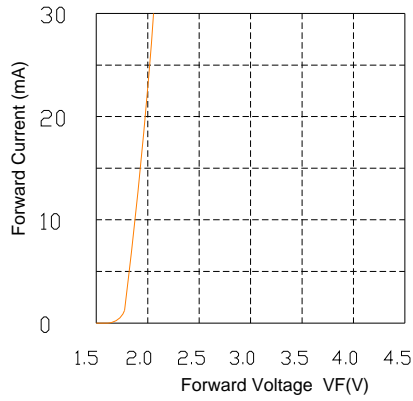

Relative Intensity vs. Forward Current (Ta=25°C)

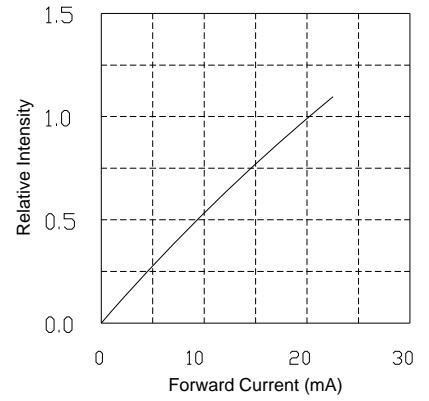

Derating

Relative Intensity vs. Ambient Temperature

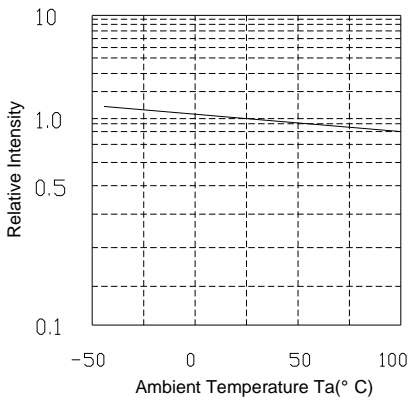

Maximum Forward Current vs. Ambient Temperature

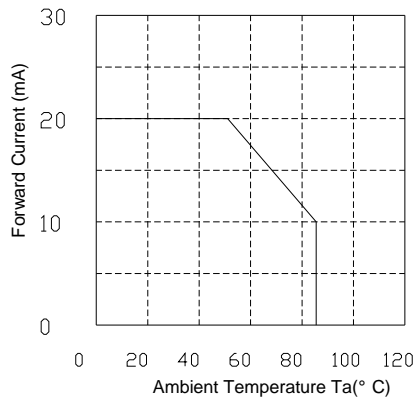

Forward Current vs. Dominate wavelength (Ta=25°C)

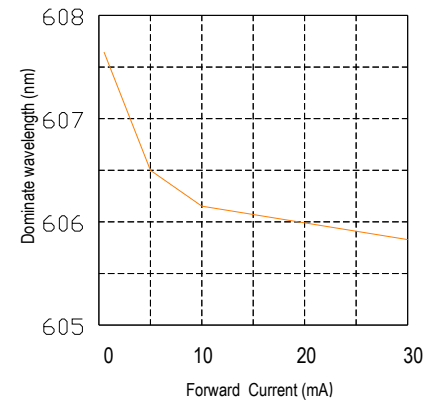
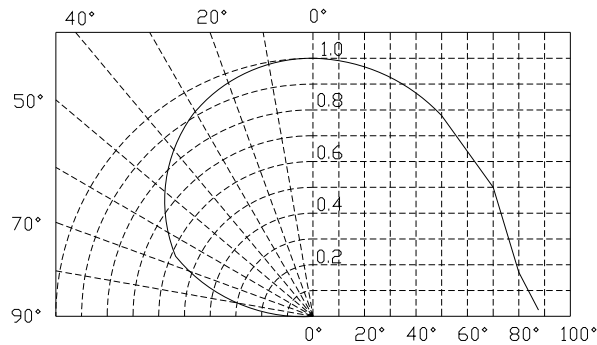

Diagram characteristics of radiation



Reflow profile

- Soldering condition
 - Recommended soldering conditions

| Reflow Soldering | | Hand Soldering | |
|------------------|------------------------------|----------------|----------------------------------|
| Pre-heat | 160~180°C | Temperature | 300°C Max. |
| Pre-heat time | 120 seconds Max. | Soldering time | 3 second Max. (one time only) |
| Peak temperature | 260°C Max. | | |
| Soldering time | 10 seconds Max. | | |
| Condition | Refer to Temperature-profile | | |

- After reflow soldering rapid cooling should be avoided

■ Temperature-profile (Surface of circuit board)

Use the following conditions shown in the figure.

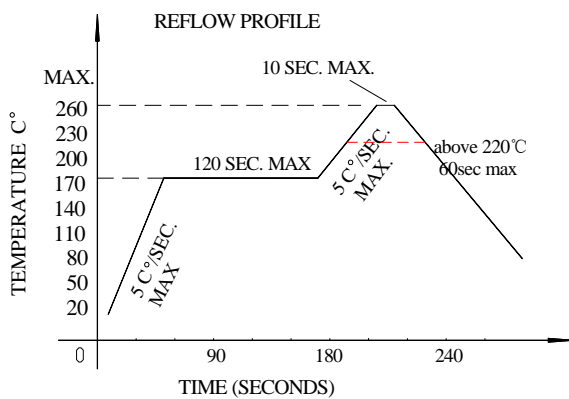

RECOMMEND PAD DESIGN (Units: mm)

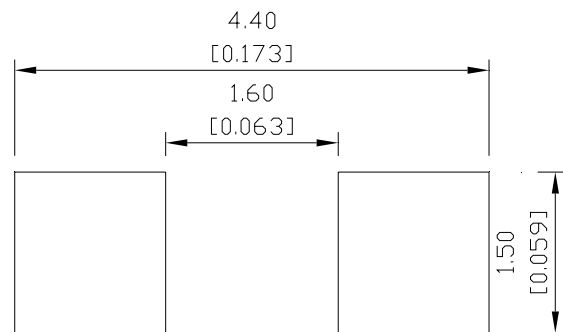

1. Reflow soldering should not be done more than two times
2. When soldering, do not put stress on the LEDs during heating

■ Soldering iron

1. When hand soldering, keep the temperature of the iron under 300°C, and at that temperature keep the time under 3 sec.
2. The hand soldering should be done only a time
3. The basic spec is ≤ 5 sec. when the temperature of 260°C, do not contact the resin when hand soldering

■ Rework

1. Customer must finish rework within 5 sec under 260°C
2. The head of iron can not touch the resin
3. Twin-head type is preferred.

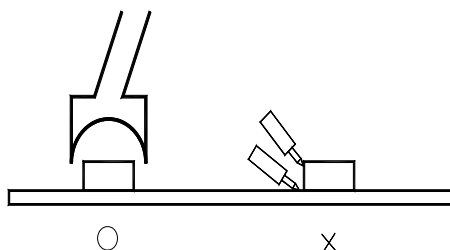



Reliability

(1)TEST ITEMS AND RESULTS

| Type | Test Item | Ref. Standard | Test Conditions | Note | Number of Damaged |
|------------------------|--|---------------|--|-----------|-------------------|
| Environmental Sequence | Resistance to Soldering Heat(Reflow Soldering) | JESD22-B106 | Tsld=260°C,10sec | 2 times | 0/22 |
| | Temperature Cycle | JESD22-A104 | -40°C 30min 25°C↑↓5min 100°C 30min | 300 cycle | 0/22 |
| | Thermal Shock | JESD22-A106 | -35°C 15min ↑↓ 85°C 15min | 300 cycle | 0/22 |
| | High Temperature Storage | JESD22-A103 | T _a =100°C | 1000 hrs | 0/22 |
| | Low Temperature Storage | JESD22-A119 | T _a =-40°C | 1000 hrs | 0/22 |
| Operation Sequence | Life Test | JESD22-A108 | T _a =25°C I _F =20mA | 1000 hrs | 0/22 |

(2)CRITERIA FOR JUDGING THE DAMAGE

| Item | Symbol | Test Conditions | Criteria for Judgement | |
|--------------------|--------|-----------------|------------------------|-------------|
| | | | Min. | Max. |
| Forward Voltage | VF | IF=20mA | - | U.S.L*)×1.1 |
| Reverse Current | IR | VR=5V | - | U.S.L*)×2.0 |
| Luminous Intensity | IV | IF=20mA | L.S.L**)*×0.5 | - |

U.S.L.: Upper Standard Level

L.S.L.: Lower Standard Level

NOTES:

1. Any reliability test standard change is confidential.



REFOND

Packaging Specifications

● Feeding Direction

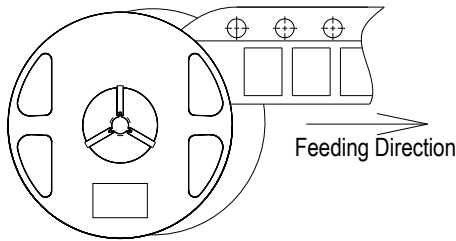

● Dimensions of Reel (Unit: mm)

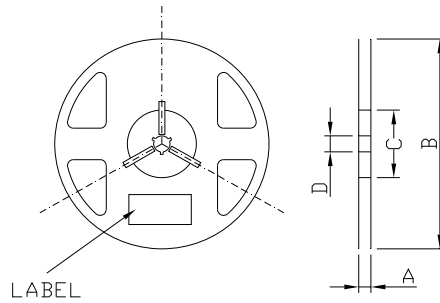

| | |
|---|------------|
| A | 8.0±0.1mm |
| B | 178±1mm |
| C | 60±1mm |
| D | 13.0±0.5mm |

● Dimensions of Tape (Unit: mm)

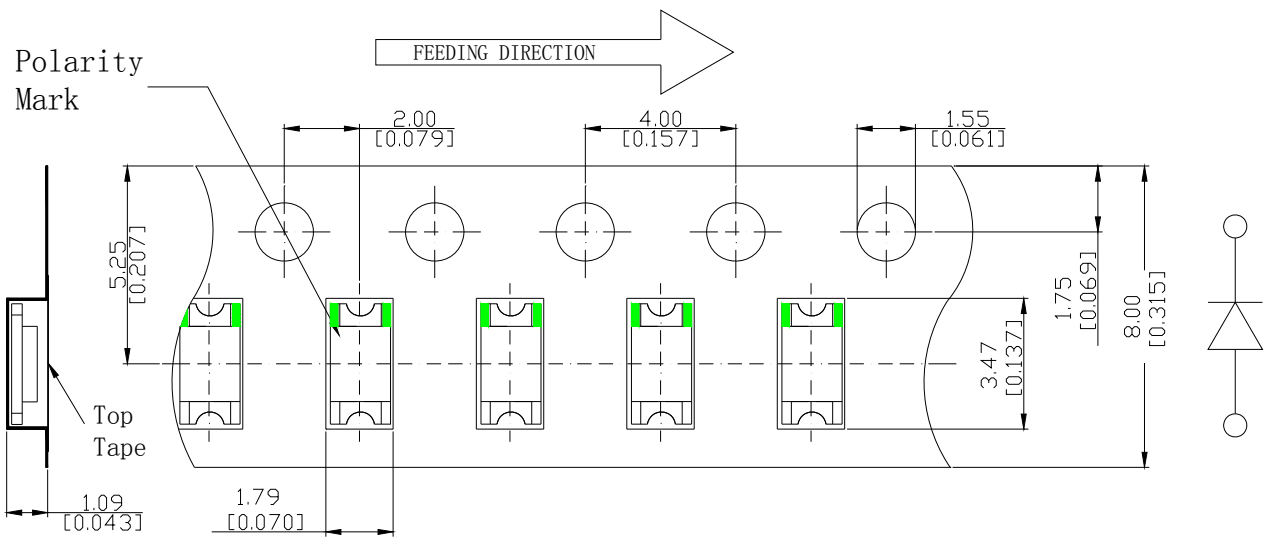

● Arrangement of Tape

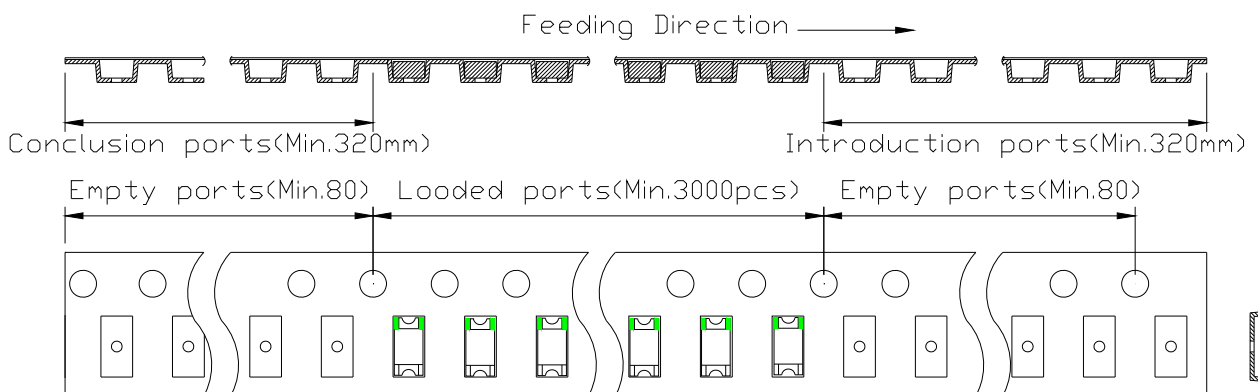

NOTES

1. Empty component pockets are sealed with top cover tape;
2. The maximum number of missing lamps is two;
3. The cathode is oriented towards the tape sprocket hole in accordance with ANSI/EIA RS-481 specifications.
4. 3,000 pcs/ Reel.



REFOND

Packaging specifications

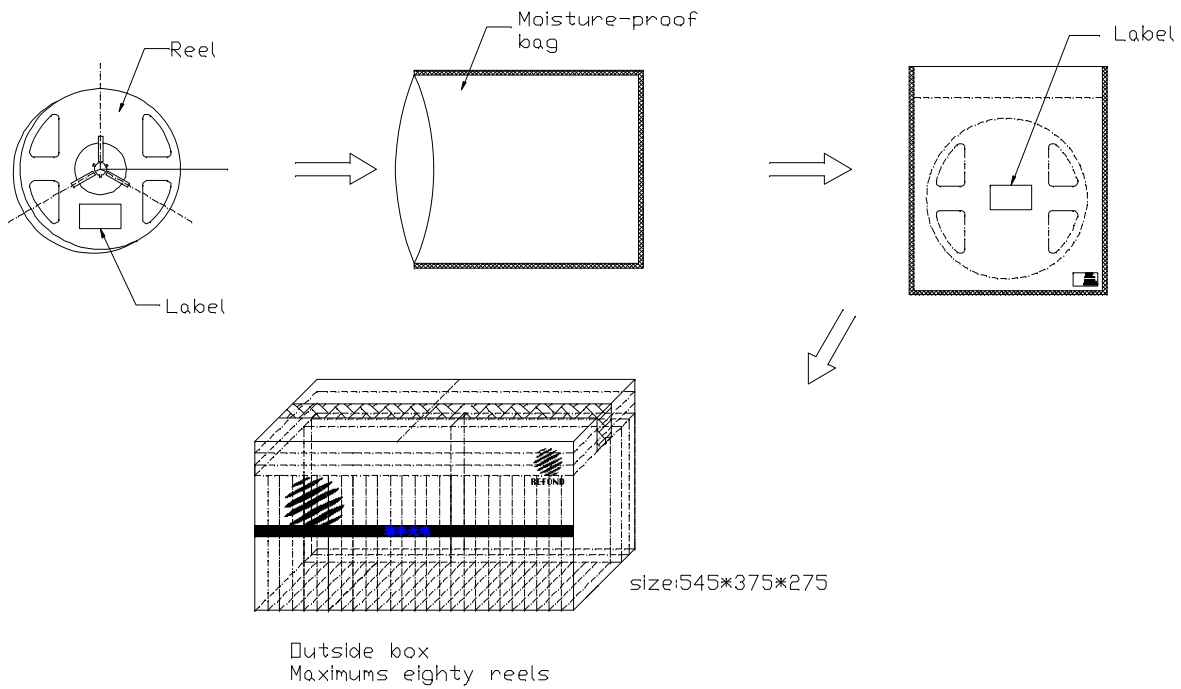

Label

| |
|--|
| PART NO: |
| SPEC NO: |
| LOT NO: |
|  |
| BIN CODE: |
| IV: |
| VF: |
| WLD: |
| QTY: PCS |
| DATE: |

CAUTIONS

Package specifications

Reeled products (numbers of products are 3,000pcs) packed in a seal off moisture-proof bag along with a desiccant one by one, Eighty moisture-proof bag of maximums are put the outside box (size: about 545mm x about 375mm x about 275mm) Together with buffer material, and it is packed. (Pare No., Lot No., quantity should appear on the label on the moisture-proof bag, part No. And quantity should appear on the label on the cardboard box.) The number of the loading steps of outside box (cardboard box) has two steps.

Storage conditions

Before opening the package:

The LEDs should be kept at 30°C or less and 70%RH or less. The LEDs should be used within a year. When storing the LEDs, moisture proof packaging with absorbent material is recommended.

After opening the package:

The LEDs should be kept at 30°C or less and 50%RH or less. The LEDs should be soldered within 168 hours (7days) after opening the package. If unused LEDs remain, they should be stored in moisture proof packages, such as sealed containers with packages of moisture absorbent material. It is also recommended to return the LEDs to the original moisture proof bag and to reseal the moisture proof bag again.