

# BL503SIRC2E-5AC

5mm, Infrared Emitting diode

Round With Flange Type

Technical Data Sheet



## Features:

- High reliability.
- General purpose leads.
- Bulk, Available on tape and reel.
- Peak wavelength  $\lambda_p=850\text{nm}$ .
- Low forward voltage.
- High radiant intensity.
- Compliance with EU REACH.
- The product itself will remain within RoHS compliant Version

## Applications:

- Optoelectronic switch.
- IR Touch-Panel.
- Industrial IR equipment.
- Consumer Electronics.
- High Speed IR Communications



## Descriptions:

- The device is spectrally matched with phototransistor, photodiode and infrared receiver module.
- The Infrared Emitting Diode (SIR series) is a high intensity diode, molded in a water clear plastic package.

## Technical Data Sheet

Part No.	Emitting Color	Lens Color
BL503SIRC2E-5AC	Infrared	Water Clear

## Package Dimensions:

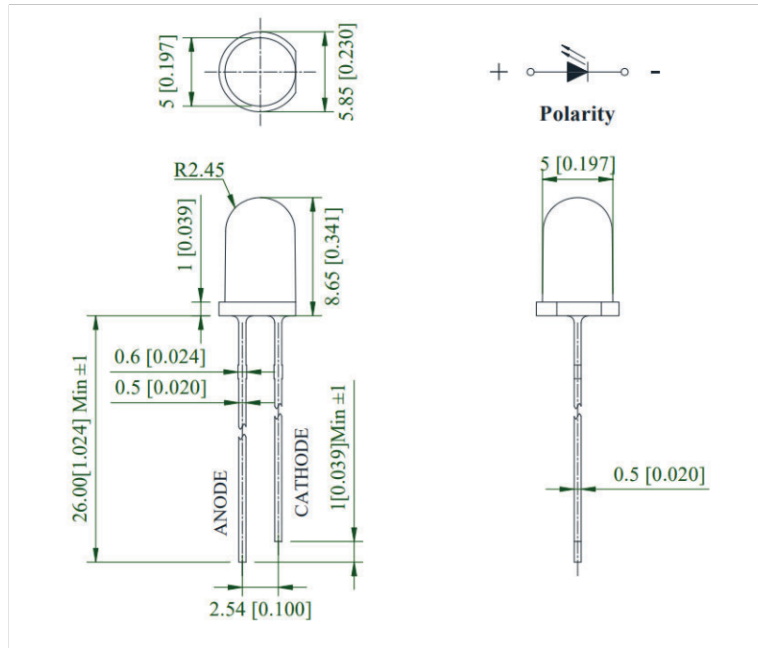

## Notes:

1. All dimensions are in millimeters (inches).
2. Tolerance is  $\pm 0.25\text{ mm}$  (.010") unless otherwise noted.
3. Protruded resin under flange is 1.00mm (.039") max.

# BL503SIRC2E-5AC

5mm, Infrared Emitting diode

Round With Flange Type

Technical Data Sheet



## Absolute Maximum Ratings at Ta=25°C

Parameters	Symbol	Max	Unit
Power Dissipation	Pd	160	mW
Peak Forward Current <sup>(a)</sup>	IFP	1	mA
DC Forward Current <sup>(b)</sup>	IF	100	mA
Reverse Voltage	VR	5	V
Operating Temperature Range	Topr	-40°C to +80°C	
Storage Temperature Range	Tstg	-40°C to +85°C	
Soldering Temperature	Tsld	260°C for 5 seconds	

Notes:

a. Derate linearly as shown in derating curve.

b. Duty Factor = 10%, Frequency = 1 kHz

## Electrical Optical Characteristics at Ta=25°C

Parameters	Symbol	Min.	Typ.	Max.	Unit	Test Condition
Radiant Intensity	Ee	7.8	15	---	mW/sr	IF=20mA
		20	45	---		IF=50mA
Viewing Angle <sup>(b)</sup>	2θ1/2	---	15	---	deg.	IF=20mA
Peak Emission Wavelength	λp	---	850	---	nm	IF=20mA
Spectral Line Half-Width	Δλ	---	45	---	nm	IF=20mA
Forward Voltage	VF	1	1.4	1.6	V	IF=20mA
		1.2	1.5	1.8		IF=50mA
Reverse Current	IR	---	---	10	μA	VR=5V

Notes:

a. 2θ1/2 is the off-axis angle at which the luminous intensity is half the axial luminous intensity.

**Typical Electrical / Optical Characteristics Curves**

**(25°C Ambient Temperature Unless Otherwise Noted)**

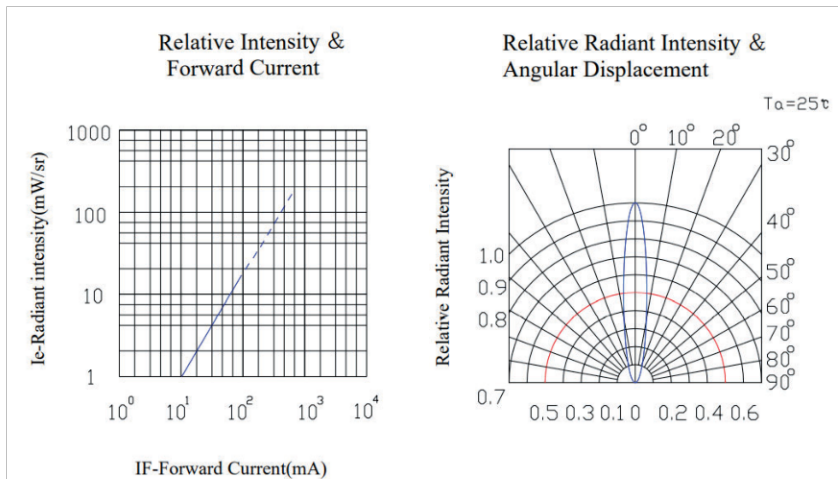
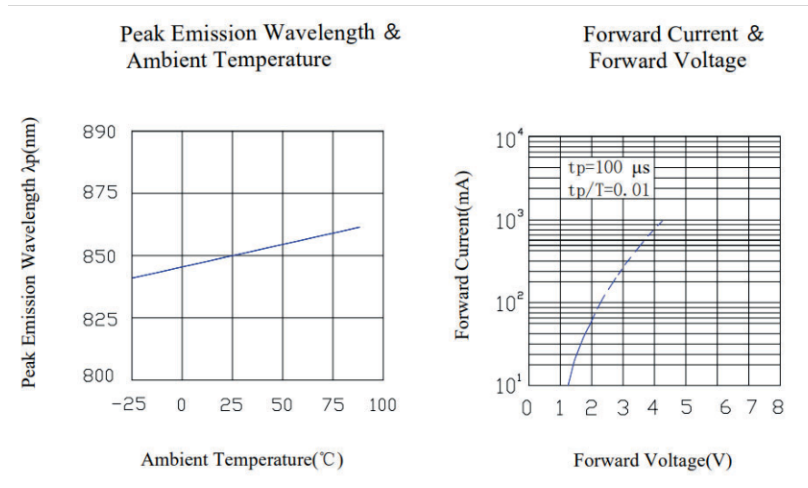
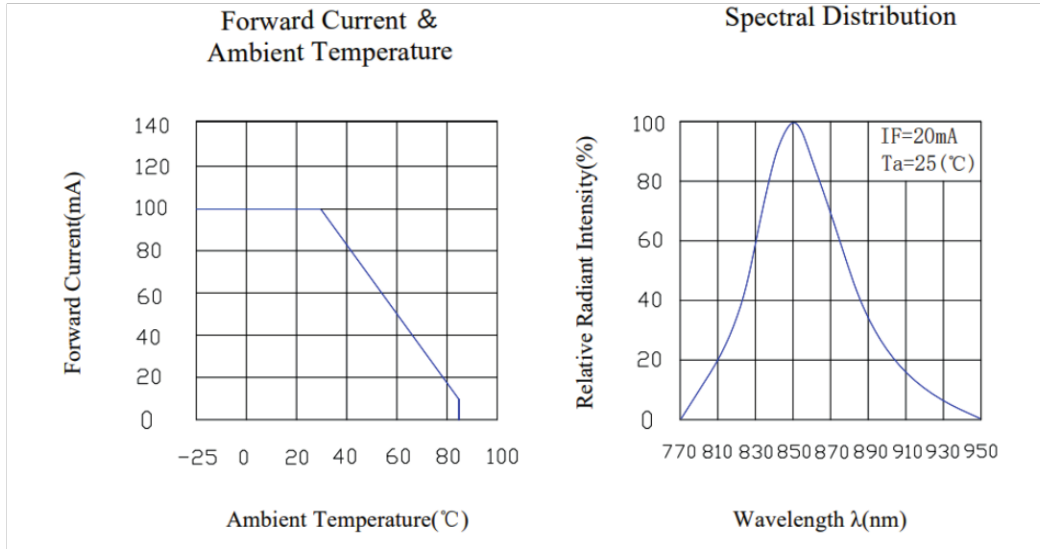

# BL503SIRC2E-5AC

5mm, Infrared Emitting diode

Round With Flange Type

Technical Data Sheet



## Typical Electrical / Optical Characteristics Curves (25°C Ambient Temperature Unless Otherwise Noted)

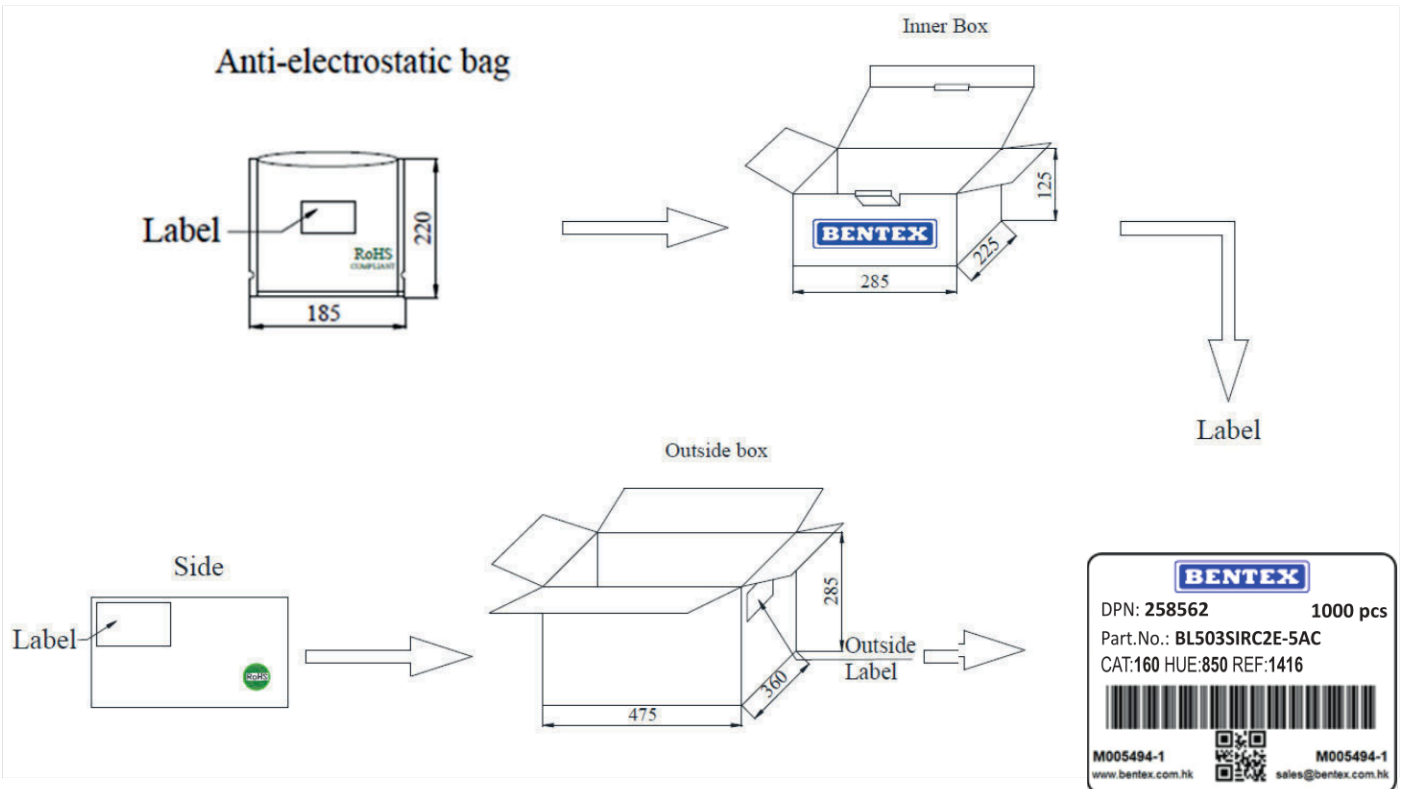
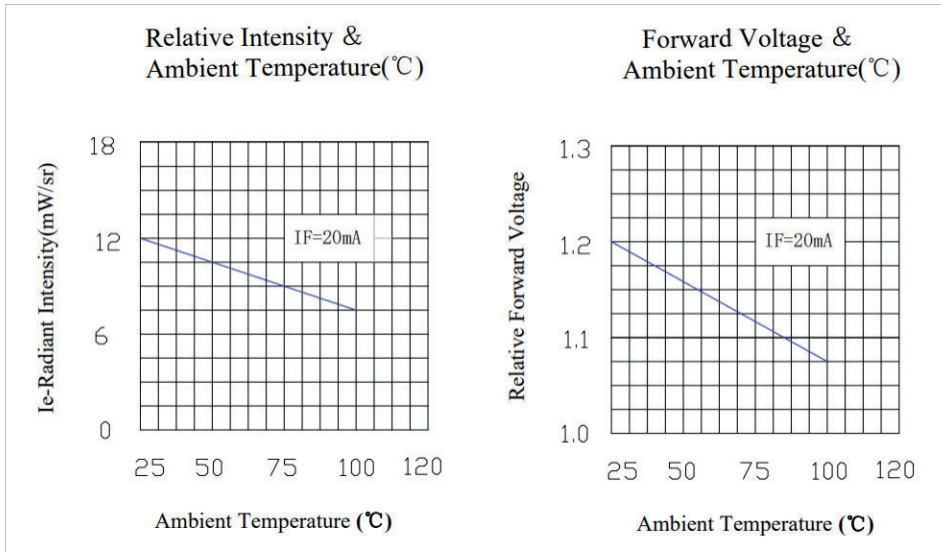

### Packing:

- a. 1000 PCS per bag.
- b. 10000 PCS per inner box.
- c. 6 Inner Boxes/Outside Box

## CAUTIONS

### 1. Over-current-proof

Customer must apply resistors for protection, otherwise slight voltage shift will cause big current change (Burn out will happen).

### 2. Storage

2.1 The LEDs should be stored at 30°C or less and 70%RH or less after being shipped from BENTEX and the storage life limits are 3 months. If the LEDs are stored for 3 months or more, they can be stored for a year in a sealed container with a nitrogen atmosphere and moisture absorbent material.

2.2 Please avoid rapid transitions in ambient temperature, especially, in high humidity environments where condensation can occur.

### 3. Cleaning

Use alcohol-based cleaning solvents such as isopropyl alcohol to clean the LEDs if necessary.

### 4. Lead Forming & Assembly

During lead forming, the leads should be bent at a point at least 1.6mm from the base of LED lens. Do not use the base of the lead frame as a fulcrum during forming. Lead forming must be done before soldering, at normal temperature. During assembly on PCB, use minimum clinch force possible to avoid excessive mechanical stress.

### 5. Soldering

When soldering, for Lamp without stopper type and must be leave a minimum of 3mm clearance from the base of the lens to the soldering point. Do not apply any external stress to the lead frame during soldering while the LED is at high temperature.

Recommended soldering conditions:

Soldering Iron		Wave Soldering	
Temperature	300°C Max.	Pre-heat	100°C Max.
		Pre-heat Time	60 sec. Max.
Soldering Time	3 sec. Max. (one time only)	Solder Wave	260°C Max.
		Soldering Time	5 sec. Max.

Note:

a. Excessive soldering temperature and / or time might result in deformation of the LED lens or catastrophic failure of the LED.

# BL503SIRC2E-5AC

5mm, Infrared Emitting diode

Round With Flange Type

Technical Data Sheet



## Recommended Wave Soldering Profiles

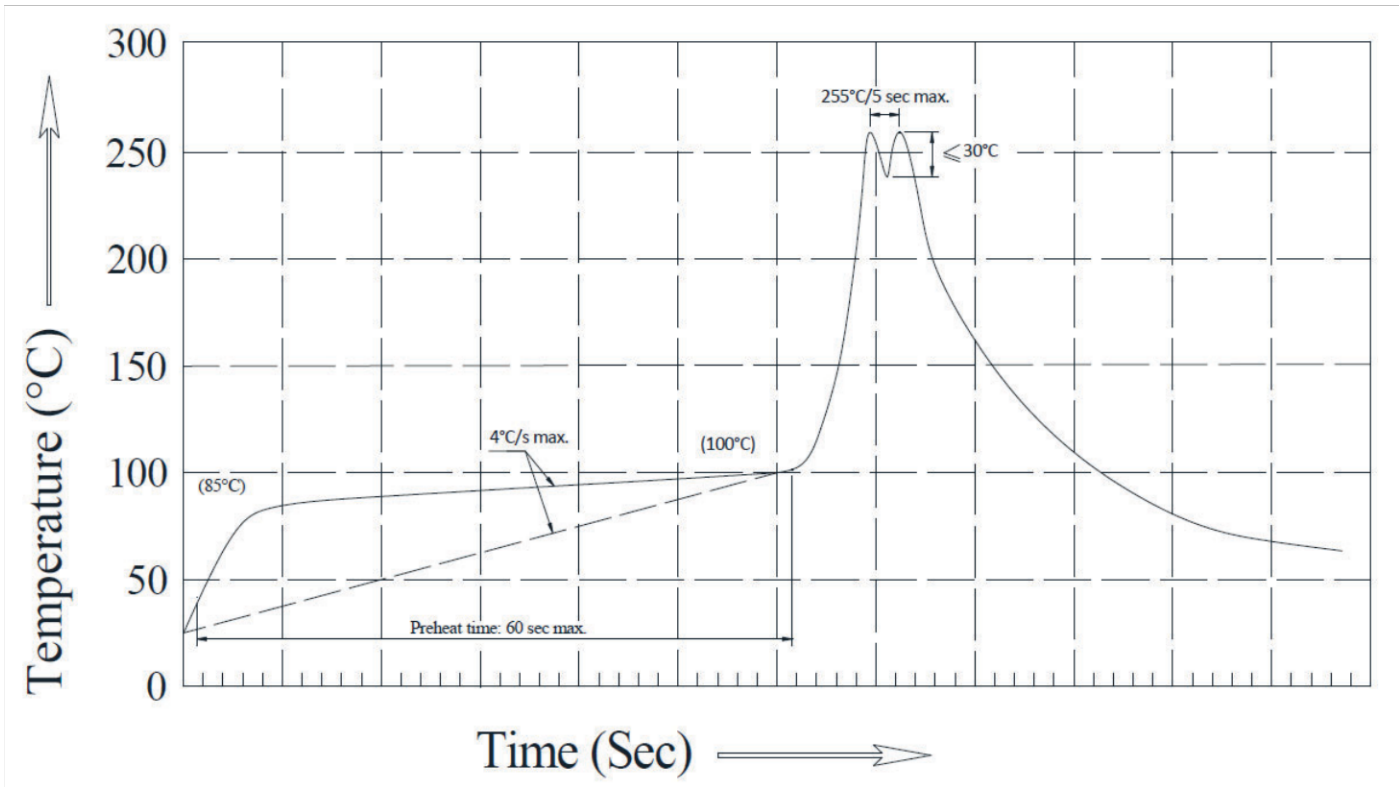

### Notes:

- a. Recommend pre-heat temperature of 105° C or less (as measured with a thermocouple attached to the LED pins) prior to immersion in the solder wave with a maximum solder bath temperature of 260° C.
- b. Peak wave soldering temperature between 245° C ~ 255°C for 3 sec (5 sec max).
- c. Do not apply stress to the epoxy resin while the temperature is above 85°C.
- d. Fixtures should not incur stress on the component when mounting and during soldering process.
- e. SAC 305 solder alloy is recommended.
- f. No more than one wave soldering pass.

## 6. Drive Method

An LED is a current-operated device. In order to ensure intensity uniformity on multiple LEDs connected in parallel in an application, it is recommended that a current limiting resistor be incorporated in the drive circuit, in series with each LED as shown in Circuit A below.

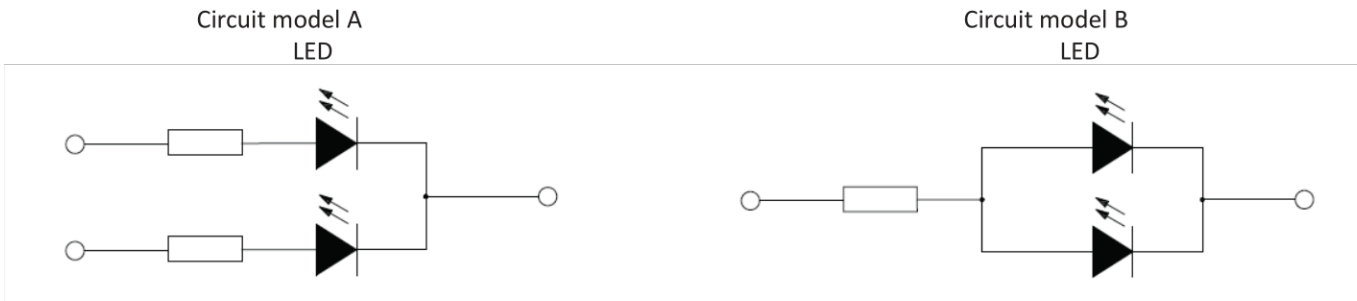

(A) Recommended circuit

(B) The brightness of each LED might appear different due to the differences in the I-V characteristics of those LEDs.

## 7. Repairing

Repair should not be done after the LEDs have been soldered. When repairing is unavoidable, a double-head soldering iron should be used. It should be confirmed beforehand whether the characteristics of the LEDs will or will not be damaged by repairing.

## 8. ESD (Electrostatic Discharge)

Static Electricity or power surge will damage the LED. Suggestions to prevent ESD damage:

8.1. Use a conductive wrist band or anti- electrostatic glove when handling these LEDs.

8.2. All devices, equipment, and machinery must be properly grounded.

8.3. Work tables, storage racks, etc. should be properly grounded.

8.4. Use ion blower to neutralize the static charge which might have built up on surface of the LEDs plastic lens as a result of friction between LEDs during storage and handing. ESD-damaged LEDs will exhibit abnormal characteristics such as high reverse leakage current, low forward voltage, or “no light up” at low currents. To verify for ESD damage, check for “light up” and VF of the suspect LEDs at low currents. The VF of “good” LEDs should be  $>2.0V@0.1mA$  for InGaN product and  $>1.4V@0.1mA$  for Alln-GaP product.

## 9. Others

9.1 The information included in this document reflects representative usage scenarios and is intended for technical reference only.

9.2 The part number, type, and specifications mentioned in this document are subject to future change and improvement without notice. Before production usage customer should refer to the latest datasheet for the updated specifications.

9.3 When using the products referenced in this document, please make sure the product is being operated within the environmental and electrical limits specified in the datasheet. If customer usage exceeds the specified limits, BENTEX will not be responsible for any subsequent issues.

9.4 The LEDs described here are intended to be used for ordinary electronic equipment (such as office equipment, communication equipment and household applications). Consult BENTEX's Sales in advance or information on applications in which exceptional reliability is required, particularly when the failure or malfunction of the LEDs may directly jeopardize life or health, such as in aviation, transportation, traffic control equipment, medical and life support systems and safety devices.