

Digital transistors (built-in resistors)

DTA143XM / DTA143XE / DTA143XUA / DTA143XKA / DTA143XSA

●Features

- 1) Built-in bias resistors enable the configuration of an inverter circuit without connecting external input resistors (see equivalent circuit).
- 2) The bias resistors consist of thin-film resistors with complete isolation to allow positive biasing of the input. They also have the advantage of almost completely eliminating parasitic effects.
- 3) Only the on/off conditions need to be set for operation, making device design easy.

●Equivalent circuit

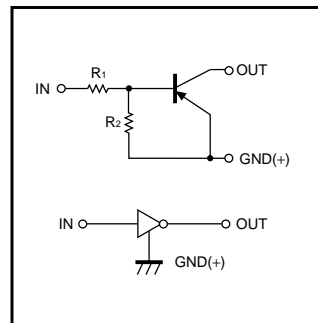

●Structure

PNP digital transistor (Built-in resistor type)

●External dimensions (Units : mm)

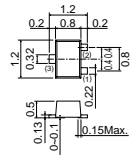
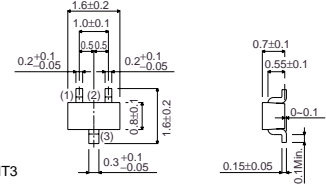
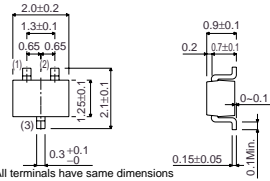
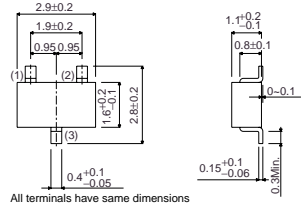
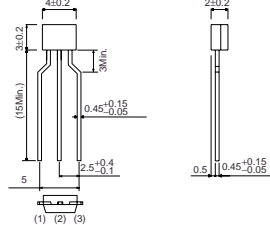
<p>DTA143XM</p>  <p>ROHM : VMT3 Abbreviated symbol : 33</p> <p>(1) IN (2) GND (3) OUT</p>	<p>DTA143XE</p>  <p>ROHM : EMT3 Abbreviated symbol : 33</p> <p>(1) GND (2) IN (3) OUT</p>
<p>DTA143XUA</p>  <p>ROHM : UMT3 EIAJ : SC-70 All terminals have same dimensions Abbreviated symbol : 33</p> <p>(1) GND (2) IN (3) OUT</p>	<p>DTA143XKA</p>  <p>ROHM : SMT3 EIAJ : SC-59 All terminals have same dimensions Abbreviated symbol : 33</p> <p>(1) GND (2) IN (3) OUT</p>
<p>DTA143XSA</p>  <p>ROHM : SPT EIAJ : SC-72</p> <p>(1) GND (2) OUT (3) IN</p>	

DTA143XM / DTA143XE / DTA143XUA DTA143XKA / DTA143XSA

Transistors

●Absolute maximum ratings (Ta=25°C)

Parameter	Symbol	Limits(DTA143X□)					Unit
		M	E	UA	KA	SA	
Supply voltage	V _{CC}	-50					V
Input voltage	V _i	-20~+7					V
Output current	I _o	-100					mA
	I _{c(Max.)}	-100					
Power dissipation	P _d	150	200			300	mW
Junction temperature	T _j	150					°C
Storage temperature	T _{stg}	-55~+150					°C

●Electrical characteristics (Ta=25°C)

Parameter	Symbol	Min.	Typ.	Max.	Unit	Conditions
Input voltage	V _{i(off)}	-	-	-0.3	V	V _{CC} =-5V, I _o =-100μA
	V _{i(on)}	-2.5	-	-		V _o =-0.3V, I _o =-20mA
Output voltage	V _{o(on)}	-	-0.1	-0.3	V	I _o /I _E =-10mA/-0.5mA
Input current	I _i	-	-	-1.8	mA	V _i =-5V
Output current	I _{o(off)}	-	-	-0.5	μA	V _{CC} =-50V, V _i =0V
DC current gain	G _i	30	-	-	-	V _o =-5V, I _o =-10mA
Input resistance	R ₁	3.29	4.7	6.11	kΩ	-
Resistance ratio	R ₂ /R ₁	1.7	2.1	2.6	-	-
Transition frequency	f _t	-	250	-	MHz	V _{CE} =-10V, I _E =5mA, f=100MHz *

* Transition frequency of the device

●Packaging specifications

Type	Package	VMT3	EMT3	UMT3	SMT3	SPT
	Packaging type	Taping	Taping	Taping	Taping	Taping
	Code	T2L	TL	T106	T146	TP
	Basic ordering unit (pieces)	8000	3000	3000	3000	5000
DTA143XM		○	-	-	-	-
DTA143XE		-	○	-	-	-
DTA143XUA		-	-	○	-	-
DTA143XKA		-	-	-	○	-
DTA143XSA		-	-	-	-	○

DTA143XM / DTA143XE / DTA143XUA
DTA143XKA / DTA143XSA

Transistors

●Electrical characteristic curves

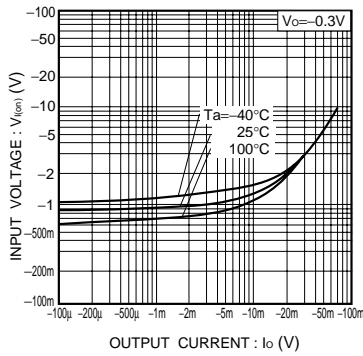

Fig.1 Input voltage vs. output current (ON characteristics)

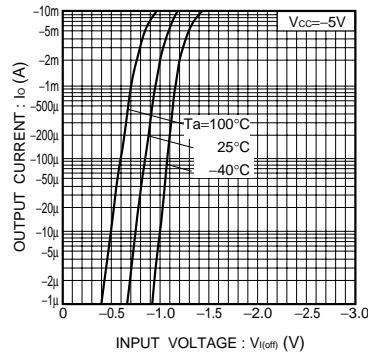

Fig.2 Output current vs. input voltage (OFF characteristics)

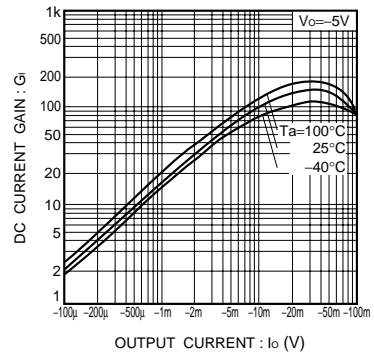

Fig.3 DC current gain vs. output current

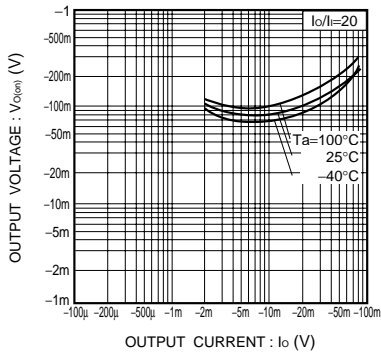

Fig.4 Output voltage vs. output current

Notes

- No technical content pages of this document may be reproduced in any form or transmitted by any means without prior permission of ROHM CO.,LTD.
- The contents described herein are subject to change without notice. The specifications for the product described in this document are for reference only. Upon actual use, therefore, please request that specifications to be separately delivered.
- Application circuit diagrams and circuit constants contained herein are shown as examples of standard use and operation. Please pay careful attention to the peripheral conditions when designing circuits and deciding upon circuit constants in the set.
- Any data, including, but not limited to application circuit diagrams information, described herein are intended only as illustrations of such devices and not as the specifications for such devices. ROHM CO.,LTD. disclaims any warranty that any use of such devices shall be free from infringement of any third party's intellectual property rights or other proprietary rights, and further, assumes no liability of whatsoever nature in the event of any such infringement, or arising from or connected with or related to the use of such devices.
- Upon the sale of any such devices, other than for buyer's right to use such devices itself, resell or otherwise dispose of the same, no express or implied right or license to practice or commercially exploit any intellectual property rights or other proprietary rights owned or controlled by
- ROHM CO., LTD. is granted to any such buyer.
- Products listed in this document use silicon as a basic material.
Products listed in this document are no antiradiation design.

The products listed in this document are designed to be used with ordinary electronic equipment or devices (such as audio visual equipment, office-automation equipment, communications devices, electrical appliances and electronic toys).

Should you intend to use these products with equipment or devices which require an extremely high level of reliability and the malfunction of which would directly endanger human life (such as medical instruments, transportation equipment, aerospace machinery, nuclear-reactor controllers, fuel controllers and other safety devices), please be sure to consult with our sales representative in advance.

About Export Control Order in Japan

Products described herein are the objects of controlled goods in Annex 1 (Item 16) of Export Trade Control Order in Japan.

In case of export from Japan, please confirm if it applies to "objective" criteria or an "informed" (by MITI clause) on the basis of "catch all controls for Non-Proliferation of Weapons of Mass Destruction.