



MMBT1616/A

NPN SILICON TRANSISTOR

NPN EPITAXIAL SILICON TRANSISTOR

■ DESCRIPTION

- * Audio frequency power amplifier
- * Medium speed switching

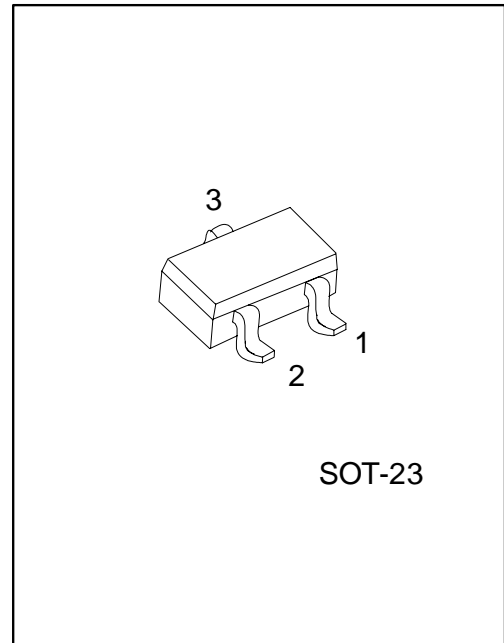

*Pb-free plating product number:
MMBT1616L/MMBT16AL

■ ORDERING INFORMATION

Order Number		Package	Pin Assignment			Packing
Normal	Lead Free Plating		1	2	3	
MMBT1616-x-AE3-R	MMBT1616L-x-AE3-R	SOT-23	E	B	C	Tape Reel
MMBT1616A-x-AE3-R	MMBT1616AL-x-AE3-R	SOT-23	E	B	C	Tape Reel

<p>MMBT1616L-x-AE3-R</p>	<p>(1) R: Tape Reel</p> <p>(2) AE3: SOT-23</p> <p>(3) x: refer to Classification of h_{FE1}</p> <p>(4) L: Lead Free Plating, Blank: Pb/Sn</p>
--------------------------	--

■ MARKING

UTC MMBT1616

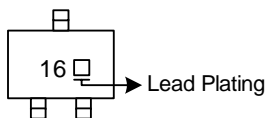

UTC MMBT1616A

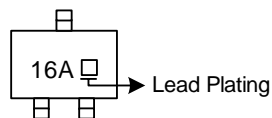

MMBT1616/A

NPN SILICON TRANSISTOR

■ ABSOLUTE MAXIMUM RATING

PARAMETER	SYMBOL	RATINGS	UNIT
Collector-Base Voltage	1616	60	V
	1616A	120	V
Collector-Emitter Voltage	1616	50	V
	1616A	60	V
Emitter to Base Voltage	V_{EBO}	6	V
Collector Current	DC	1	A
	Pulse*	2	A
Total Power Dissipation ($T_a=25$)	P_C	350	mW
Junction Temperature	T_J	+150	
Storage Temperature	T_{STG}	-55 ~ +150	

Note (*) Pulse width \leq 10ms, Duty cycle $<$ 50%

1. Absolute maximum ratings are those values beyond which the device could be permanently damaged. Absolute maximum ratings are stress ratings only and functional device operation is not implied.

■ ELECTRICAL CHARACTERISTICS ($T_a=25$)

PARAMETER	SYMBOL	TEST CONDITIONS	MIN	TYP	MAX	UNIT
Collector Cut-Off Current	I_{CBO}	$V_{CB}=60V$			100	nA
Emitter Cut-Off Current	I_{EBO}	$V_{EB}=6V$			100	nA
Collector-Emitter Saturation Voltage	$V_{CE(SAT)}$	$I_C=1A, I_B=50mA$		0.15	0.3	V
Base-Emitter Saturation Voltage	$V_{BE(SAT)}$	$I_C=1A, I_B=50mA$		0.9	1.2	V
Base Emitter On Voltage	$V_{BE(ON)}$	$V_{CE}=2V, I_C=50mA$	600	640	700	mV
DC Current Gain	h_{FE1}	$V_{CE}=2V, I_C=100mA$	135		600	
	h_{FE2}	$V_{CE}=2V, I_C=1A$	81		400	
Current Gain Bandwidth Product	f_T	$V_{CE}=2V, I_C=100mA$	100	160		MHz
Output Capacitance	C_{ob}	$V_{CB}=10V, f=1MHz$			19	pF
Turn On Time	t_{ON}	$V_{CE}=10V, I_C=100mA$		0.07		us
Storage Time	t_S	$I_{B1}=-I_{B2}=10mA$		0.95		us
Fall Time	t_F	$V_{BE(OFF)}=-2 \sim -3V$		0.07		us

■ CLASSIFICATION OF h_{FE1}

RANK	Y	G	L
h_{FE1}	135-270	200-400	300-600

■ TYPICAL CHARACTERISTICS

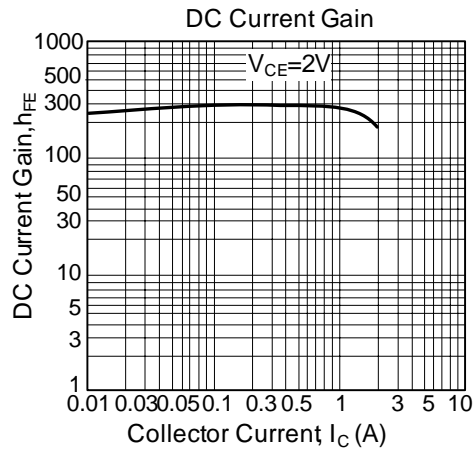
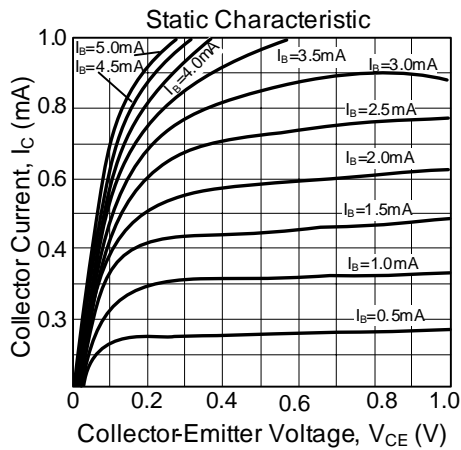
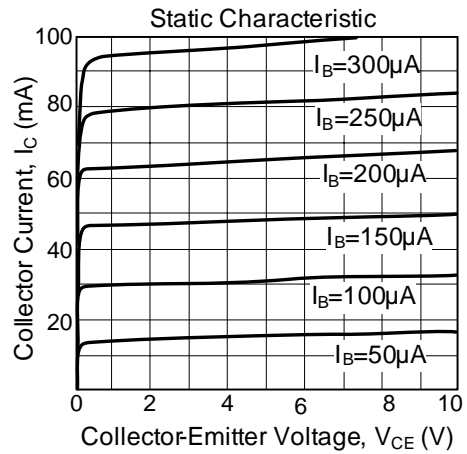
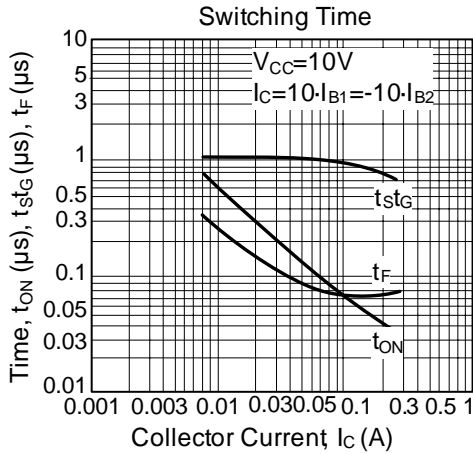
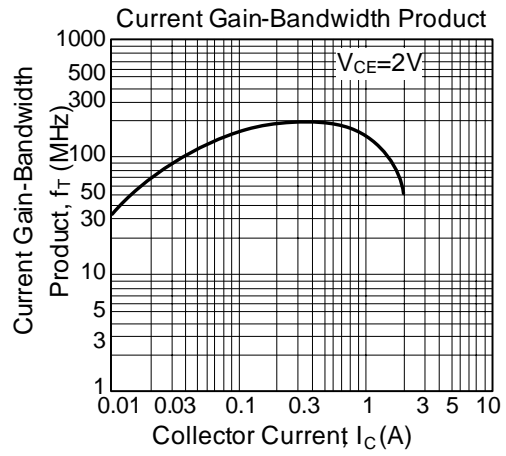
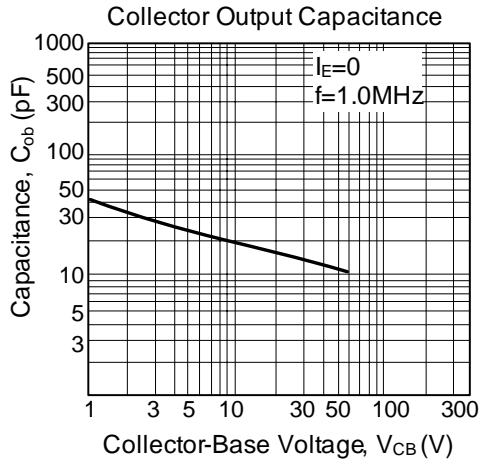

■ TYPICAL CHARACTERISTICS(Cont.)

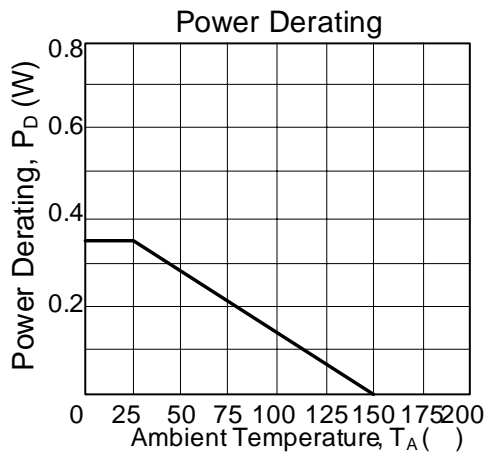
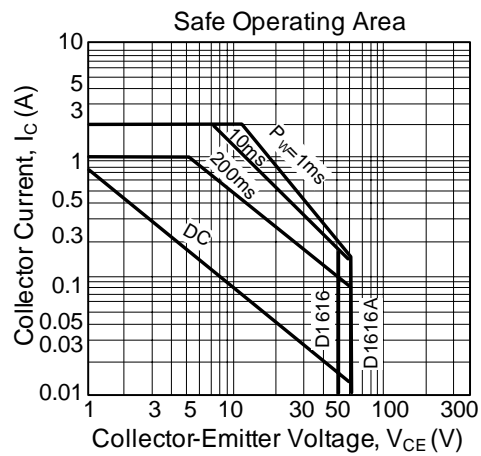
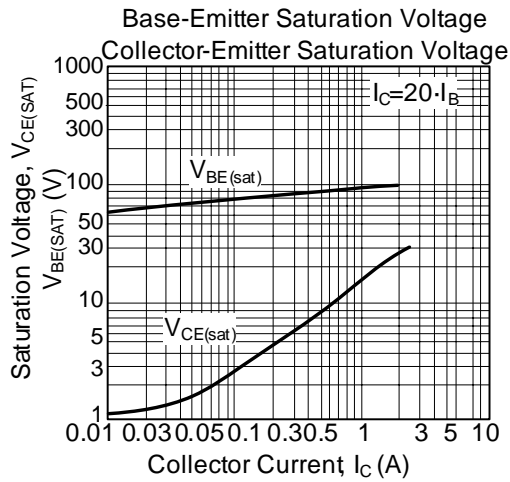

UTC assumes no responsibility for equipment failures that result from using products at values that exceed, even momentarily, rated values (such as maximum ratings, operating condition ranges, or other parameters) listed in products specifications of any and all UTC products described or contained herein. UTC products are not designed for use in life support appliances, devices or systems where malfunction of these products can be reasonably expected to result in personal injury. Reproduction in whole or in part is prohibited without the prior written consent of the copyright owner. The information presented in this document does not form part of any quotation or contract, is believed to be accurate and reliable and may be changed without notice.